

---

---

# User Guide

---

## Refrigerated Recirculating Chillers

---

---



# Table of Contents

<b>Introduction</b> .....	<b>3</b>
<b>General Information</b> .....	<b>4</b>
General Safety Information .....	4
Safety Recommendations .....	4
Unpacking Your Chiller .....	5
Regulatory and Compliance Testing .....	5
Contents .....	5
<b>Controls and Components</b> .....	<b>6</b>
Front View – Air-Cooled Models .....	6
Rear View – Air-Cooled Models .....	6
Front View – Water-Cooled Models .....	7
Rear View – Water-Cooled Models .....	7
<b>Quick Start</b> .....	<b>8</b>
<b>Installation and Startup</b> .....	<b>9</b>
Site Requirements.....	9
Ambient Temperature and Relative Humidity .....	9
Location .....	9
Clearance .....	9
Electrical Power .....	9
Optional Signal Inputs/Outputs .....	10
External Ambient Tracking Temperature Probe .....	10
RS232 / RS485 Serial Output .....	10
Remote I/O Port.....	10
Plumbing .....	10
Process Piping.....	10
Facility Water Connections.....	10
Reservoir Drain.....	11
External Water Filter.....	11
Closed System or Cooling Coil Setup.....	11
Open Bath System Setup .....	11
Startup.....	12
Facility Water Flow (Water-Cooled Models Only) .....	12
Process Coolant .....	12
Electrical Power.....	14
Starting Process Fluid Flow.....	14
<b>Normal Operation</b> .....	<b>15</b>
Selecting the Temperature Unit .....	15
Displaying and Adjusting the Set Point.....	15
Displaying and Adjusting the Ambient Tracking Offset.....	15
Displaying and Adjusting the Remote Control Temperature .....	16
Selecting the Pressure / Flow Rate Display and Units .....	16
Selecting the Internal / External Temperature Display .....	16
Setting Operational Parameters.....	17
High Temperature Limit (HL).....	18
Low Temperature Limit (LL) .....	18
High Ambient Temperature Limit (HA) .....	18
Maximum Fluid Pressure (FP).....	18
Minimum Flow Rate (FL) .....	19
Maximum External / Internal Temperature Differential (Sd).....	19
Auto-Refrigeration Temperature (AF).....	20
Remote Probe (rP) .....	20
Internal Calibration Offset (c1) .....	21
External Calibration Offset (c2) .....	21
Flow Rate Calibration (Fc).....	22
Baud Rate (PC) .....	22

<b>Display, Alarm and Error Messages .....</b>	<b>23</b>
<b>Adjusting the High Pressure Bypass Setting .....</b>	<b>26</b>
<b>Enabling / Disabling the Local Lockout .....</b>	<b>26</b>
<b>Routine Maintenance and Troubleshooting .....</b>	<b>27</b>
Routine Maintenance .....	27
Pump Lubrication.....	27
Pump Drain.....	27
Condenser, Air Vents and Reusable Filter (Air-Cooled Models only) .....	28
Fluid Filter .....	28
Fluid Level .....	28
Temperature Calibration.....	28
Troubleshooting .....	29
Diagnostic Mode .....	30
<b>Technical Information .....</b>	<b>31</b>
General Specifications (all Chillers) .....	31
Pump Performance .....	31
Magnetic Drive Centrifugal Pump.....	31
Positive Displacement Pump.....	32
Turbine Pump .....	32
Performance Specifications – 60Hz Chillers.....	33
Air-Cooled 1/4-HP, 1/3-HP and 1/2-HP Chillers.....	33
Air-Cooled 3/4-HP and 1-HP Chillers .....	35
Water-Cooled 3/4-HP Chillers .....	36
Performance Specifications – 50Hz Chillers.....	37
Air-Cooled 1/4-HP, 1/3-HP and 1/2-HP Chillers.....	37
Air-Cooled 3/4-HP and 1-HP Chillers .....	39
Water-Cooled 3/4-HP Chillers .....	40
<b>Diagrams and Schematics .....</b>	<b>42</b>
Electrical Wiring Diagram.....	42
Flow Schematic.....	43
Remote On/Off Status Alarm Pinout .....	44
<b>Replacement Parts .....</b>	<b>45</b>
<b>RS232 Communications .....</b>	<b>47</b>
<b>Certificate of Compliance .....</b>	<b>48</b>
<b>Equipment Disposal (WEEE Directive).....</b>	<b>49</b>
<b>Service and Technical Support .....</b>	<b>49</b>
<b>Warranty .....</b>	<b>50</b>

## Introduction

Your Recirculating Chiller provides cooling power for demanding applications and serves as an economical alternative to tap water cooling systems. Extremely easy to use and maintain, it combines technological innovation with precise temperature control to deliver reliable heat removal for a wide variety of applications.

Here are some of the features that make your Chiller so user-friendly:







- Microprocessor-based temperature controller
- Large, easy to read digital temperature display (°C or °F)
- One-touch temperature set point adjustment
- Digital pressure/flow rate display (PSI, kPa, GPM, LPM) with push-button selection
- Cool Command™ modulated refrigeration system for enhanced temperature stability and extended compressor life
- Centrifugal, positive displacement, or regenerative turbine pump

It will take you very little time to get your Recirculating Chiller installed and running. This manual is designed to guide you quickly through the process. We recommend that you read it thoroughly before you begin.

# General Information

## General Safety Information

When installed, operated, and maintained according to the directions in this manual and common safety procedures, your Chiller should provide safe and reliable heat removal. Please ensure that all individuals involved in the installation, operation, or maintenance of this unit read this manual thoroughly prior to working with the unit.

	This symbol alerts you to wide range of potential dangers.
	This symbol advises you of danger from electricity or electric shock.
	This symbol marks information that is particularly important.
	This symbol indicates alternating current.
	These symbols on the Power Switch / Circuit Breaker indicate that they place the main power supply ON / OFF.
	This symbol on the Power Switch indicates that it places the unit in a standby mode. It DOES NOT fully disconnect the unit from the power supply.
	This symbol indicates a protective conductor terminal.

**Read all instructions pertaining to safety, set-up, and operation.  
Proper operation and maintenance is the user's responsibility.**

## Safety Recommendations

To prevent injury to personnel and/or damage to property, always follow your workplace's safety procedures when operating this equipment. You should also comply with the following safety recommendations:

	<ul style="list-style-type: none"><li>• Always connect the power cord on this unit to a grounded (3-prong) power outlet. Make certain that the outlet is the same voltage and frequency as your unit.</li><li>• Never operate the unit with a damaged power cord.</li><li>• Always turn the unit OFF and disconnect Mains power before performing any maintenance or service.</li></ul>
---	---

## Unpacking Your Chiller

Your Chiller is shipped in a special carton. Retain the carton and all packing materials until the unit is completely assembled and working properly. Set up and run the unit immediately to confirm proper operation. Beyond one week, your unit may be warranty repaired, but not replaced. If the unit is damaged or does not operate properly, contact the transportation company, file a damage claim and contact the company where your unit was purchased immediately.



**CAUTION:** Keep unit upright when moving. Be sure to follow your company's procedures and practices regarding the safe lifting and relocation of heavy objects.

## Regulatory and Compliance Testing

### Canada USA (60Hz units)

CAN/CSA C22.2 No. 61010-1-12 — Safety Requirements for Electrical Equipment for Measurement, Control and Laboratory Use, Part I: General Requirements.

CAN/CSA C22.2 No. 61010-2-010-04 (R2014) – Safety Requirements for Electrical Equipment for Measurement, Control and Laboratory Use – Part 2-010: Particular Requirements for Laboratory Equipment for the Heating of Materials.

UL Std No. 61010-1 (2012) — Electrical Equipment for Laboratory Use, Part I: General Requirements.

UL Std No. 61010-2-010 (2015) – Electrical Equipment for Laboratory Use, Part 2: Particular Requirements for Laboratory Equipment for the Heating of Materials.

### CE (50Hz units)

Machinery Directive 2006/42/EC

EC Electromagnetic Compatibility Directive 2014/30/EU

IEC 61010-1 / EN 61010-1:2010

IEC 61010-2-010 / EN 61010-2-010:2014

IEC 61326:2012 / EN 61326:2013

RoHS Directive 2011/65/EU

### Highly Accelerated Life Test (HALT) and Vibration Tests per ASTM D4169-8 (All units)

## Contents

The following items have been included with your Chiller:

- Operator's Manual
- IEC Power Cord
- Two sets of Inlet/Outlet Adapters: ½ inch male NPT x ½ inch hose barb and ½ inch male NPT x 5/8 inch hose barb (select models)

# Controls and Components

## Front View — Air-Cooled Models

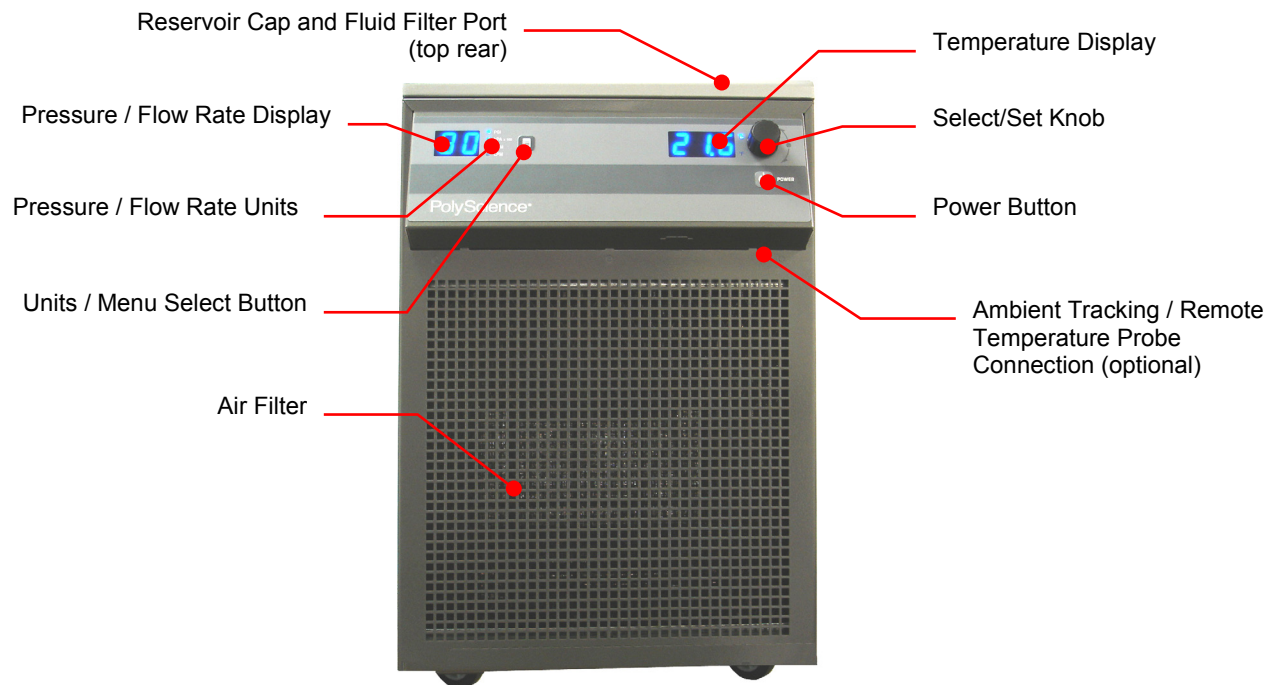

## Rear View — Air-Cooled Models

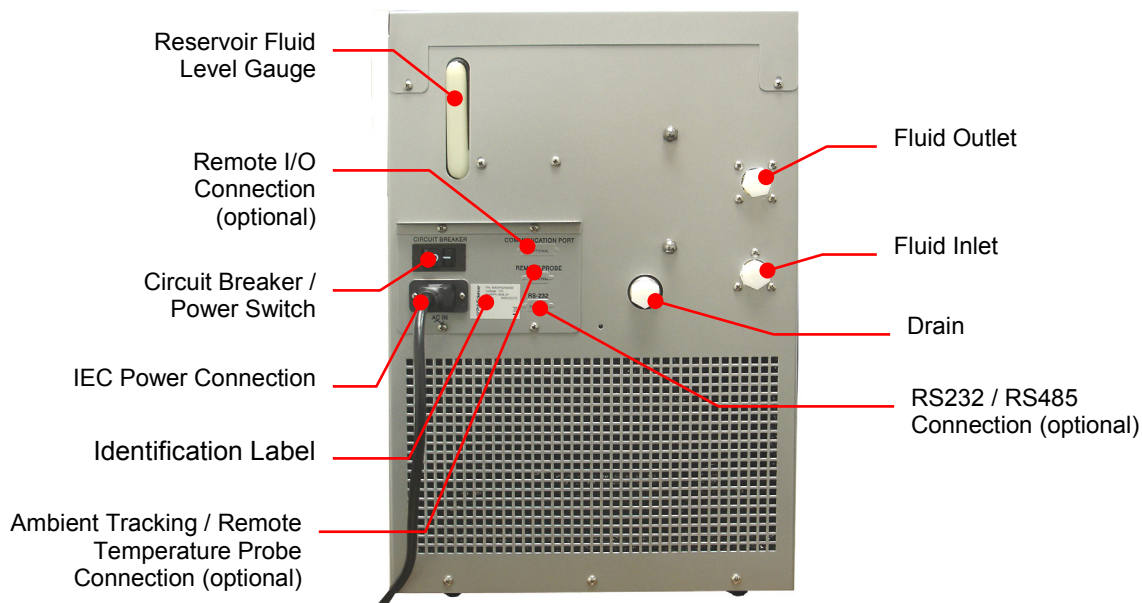

## Front View — Water-Cooled Models

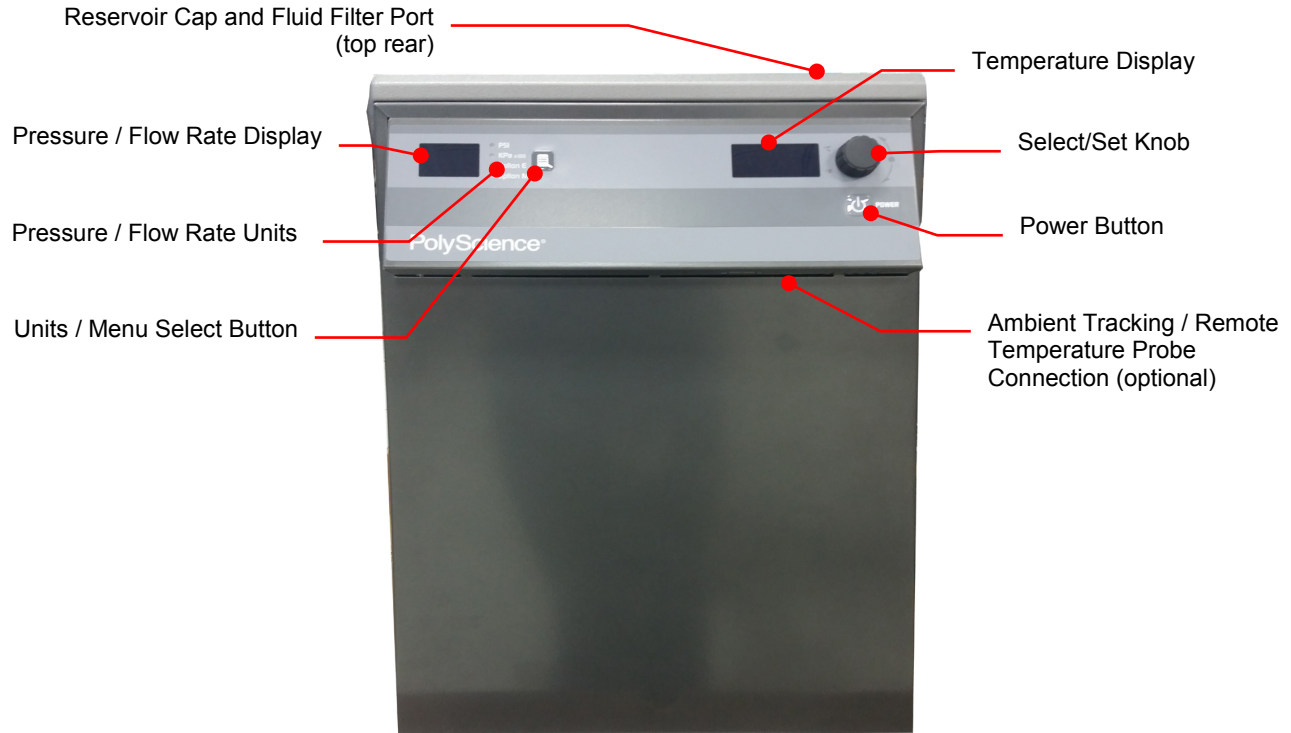

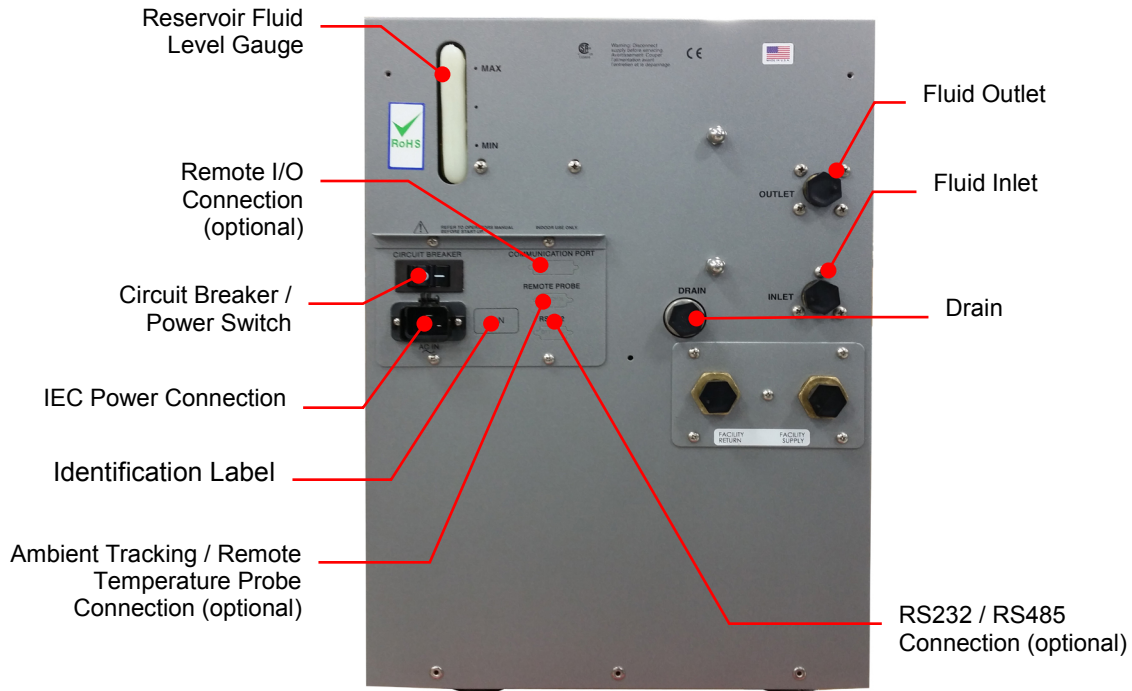

## Rear View — Water-Cooled Models



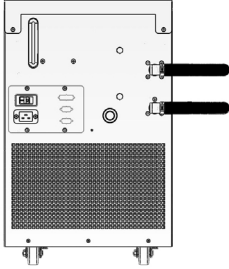
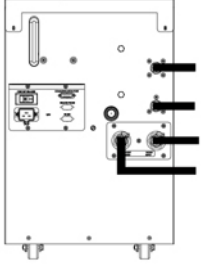
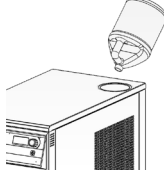
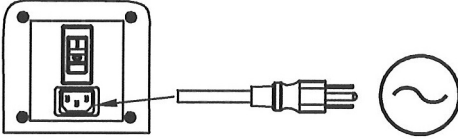
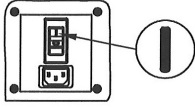
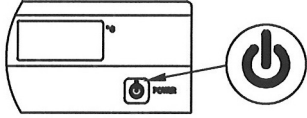
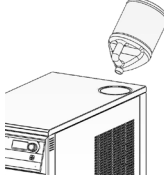

# Quick Start

See Installation & Startup for additional information.

<p><b>1</b></p>	<p><b>All models:</b> Connect all process lines</p> <p><b>Water-cooled models:</b> Connect facility water lines and start flow of facility water</p>	 <p>Air-Cooled Models</p>	 <p>Water-Cooled Models</p>
<p><b>2</b></p>	<p>Fill reservoir with coolant</p>		
<p><b>3</b></p>	<p>Connect electrical power cord to Mains</p>		
<p><b>4</b></p>	<p>Turn Power Switch / Circuit Breaker ON</p>		
<p><b>5</b></p>	<p>Turn Controller ON</p>		
<p><b>6</b></p>	<p>Add coolant to reservoir as process lines fill</p>		
<p><b>7</b></p>	<p>Enter temperature set point</p>		

## Installation and Startup



**WARNING:** Be sure all power is off before proceeding.

### Site Requirements

#### Ambient Temperature and Relative Humidity

The Chiller is designed for indoor installation in ambient temperatures between 5° and 30°C (41° and 86°F); relative humidity should not exceed 80% (non-condensing).

#### Location

The Chiller should be installed on a strong, level surface. It should be located as close to possible to the process requiring cooling. It should not be installed closer than 4 feet (1.4 meters) to a heat-generating source, such as heating pipes, boilers, etc. If possible, the Chiller should be located near a suitable drain to prevent flooding in the event of leaks. Do not place it where corrosive fumes, excessive moisture, excessive dust, or high room temperatures are present.

For ease of positioning and maneuverability, the Chiller is supplied with casters. The front wheels can be locked to keep the Chiller in place while in use.

To help prevent voltage drops, position the Chiller as close as possible to the power distribution panel. Avoid voltage drops by using a properly grounded power outlet wired with 14 gauge or larger diameter wire. The use of an extension cord is not recommended.



**NOTE:** The Chiller may be located at a level below that of the equipment being cooled. As long as the process remains closed, overflow will not occur when adding cooling fluid to the Chiller reservoir.

### Clearance

Adequate clearance should be allowed on the front, sides, and rear of the Chiller for access to connections and components. The front and rear vents of the Chiller must be a minimum of 24 inches (61 cm) away from walls or vertical surfaces so air flow is not restricted.

### Electrical Power

An IEC power cord is provided with the Chiller. It should be attached to the receptacle on the rear of the enclosure. Make sure that the power outlet used for the Chiller is properly grounded and matches the voltage and frequency indicated on the identification label on the back of the Chiller.

The use of an extension cord is not recommended. However, if one is necessary, it must be properly grounded and capable of handling the total wattage of the unit. The extension cord must not cause more than a 10% drop in voltage to the Chiller.



**WARNING:** DO NOT plug the Chiller into the electrical outlet until the unit is ready for startup (see *Startup*).

## Optional Signal Inputs/Outputs

### External Ambient Tracking Temperature Probe

This option allows you to control the cooling fluid temperature using an external temperature measurement (ambient room/machine temperature or process temperature). A 9-pin connector is provided on either the underside of the local control panel or on the rear panel for connecting the external probe.



**NOTE:** In order for the Chiller to properly recognize the presence of the external temperature probe, the probe must be connected to the unit before power is applied.

### RS232 / RS-485 Serial Output

This option allows you to remotely control the Chiller and/or output temperature readings to an external recorder or other auxiliary device. The maximum communications distance for Chillers equipped with the RS232 option is 50 feet (15 meters). The maximum distance for units equipped with the RS485 option is 4000 feet (1200 meters). A 9-pin D-connector is provided on the rear of the instrument enclosure for this connection.

### Remote I/O Port

This option allows you to use an external 12 VDC signal or a dry contact closure to turn the Chiller on and off. Chiller status is also available from this port. A 15-pin D-connector is provided on the rear of the instrument enclosure for this connection. See schematic at the end of this manual.

## Plumbing

### Process Piping

The Chiller has two internally threaded (1/2 inch ID NPT) fittings on the rear of the instrument housing for the process water connections. Two sets of adapters (1/2 inch ID and 5/8 inch ID) are supplied with the unit for connecting these fittings to the process piping.

To maintain a safe workplace and avoid leaks, special care should be taken when choosing hoses and connectors for the Chiller. It is the user's responsibility to ensure that the tubing and fittings connected to the Chiller are compatible with the fluid, temperature, and pressure being used.

- **Pressure Ratings** — Hoses should be able to withstand the largest pressure that they will encounter. For "P" Series (positive displacement pump) and "T" Series (turbine pump) Chillers, this is 100 psi (689 kPa).
- **Flexible Tubing** — Avoid tubing that will expand and take up fluid volume when operating at the desired pressure.
- **Hose Diameter** — Process piping/hosing with a diameter smaller than 1/2 inch ID can be used if desired. However, keep in mind that using smaller diameter hosing increases pressure in the circulating system.
- **Couplings and Clamps** — The use of screw-tightened hose clamps is necessary on all joints to insure good, tight connections. Quick connectors are not recommended as they have the potential for restricting flow rate.

### Facility Water Connections



**WARNING:** The incoming cooling water pressure should be 20 psi / 1.4 bar minimum and 100 psi / 689 kPa bar maximum.

Water-cooled Chillers have two internally threaded (0.50 inch ID NPT) on the rear of the instrument housing for the facility water connections. The cooling water supply should be connected to the facility water inlet on the Chiller. The facility water outlet on the Chiller should be connected to the appropriate return or drain, as required.

The cooling water supply may be from city tap water or a cooling tower. The incoming water pressure should be between 20 and 100 psi / 1.4 and 689 kPa. The temperature of the incoming water supply should be between 8°C and 30°C (46°F and 86°F). The flow rate requirement to achieve the specified cooling capacity is 3 gpm (11.4 lpm) at 20°C (68°F) facility water.

## Reservoir Drain

A ½ inch NPT connection is provided for the reservoir's gravity drain. It should be piped to a drain or receptacle positioned below the bottom of the reservoir. If a receptacle is used, be sure it is of sufficient volume to hold all the water in the reservoir, process, and process lines.

## External Water Filter

An optional water filter is available that can be connected to the Chiller's fluid inlet or fluid outlet. Consult supplier for additional information.

## Closed System or Cooling Coil Setup

Connect the Chiller's inlet and outlet to the external apparatus with hoses or pipes. The direction of the flow through the system can be controlled by the way the connections are made. Fluid is drawn into the Chiller through the "Inlet" connection; fluid is pumped out of the Chiller through the "Outlet" connection.



**NOTE:** When Chillers with the standard magnetic drive centrifugal pump are connected to an external apparatus with a built-in shutoff, an external bypass loop assembly (Cat. No. 510-147) may be needed if operating below 20°C (68°F). This bypass assembly continues flow circulation to and from the pump even when the main flow to the external apparatus is blocked.

## Open Bath System Setup

Position the external tank at least two feet (0.6 meter) above the Chiller's inlet.

Install a shutoff valve on both the inlet and outlet of the Chiller. Place the valves in the closed position.

Connect the shutoff valves to the external tank using the tubing of equal diameter (1/2 inch minimum) and length. Use the same size fittings on both the inlet and outlet; this will ensure a balanced flow.

Cut the external end of the suction (inlet) tube into a "V" shape so that the tube will not seal itself against the wall of the external tank. Both the pressure and suction tubing should be securely fastened to the external tank to prevent movement during use. When using flexible tubing, the suction (inlet) tubing must have a wall thickness that will not collapse under vacuum, particularly when going around bends.

Fill the external bath (see *Startup, Process Coolant* for suitable fluids).

Fill the Chiller reservoir to the top of the filler neck and install the filter screen and cap. Tighten the cap until it is securely sealed.

## Startup

### Facility Water Flow (Water-Cooled Models Only)



**WARNING:** The incoming cooling water pressure should be 20 psi / 1.4 bar minimum and 100 psi / 689 kPa bar maximum.



**NOTE:** The temperature of the incoming water supply should be between 8°C and 30°C (46°F and 86°F). The flow rate requirement to achieve the specified cooling capacity is 3 gpm (11.4 lpm) at 20°C (68°F) facility water.

1. Open the valves to the facility water supply and return.
2. Check for leaks.

### Process Coolant

#### Suitable Fluids



**WARNING:** Only use fluids that will satisfy safety, health, and equipment compatibility requirements. Caustic, corrosive, or flammable fluids must never be used.



**WARNING:** Do not use caustic, corrosive, or flammable fluids.



**WARNING:** Operation below 15°C (59°F) requires antifreeze in the circulation fluid.



**WARNING:** FOR CHILLERS WITH MAGNETIC DRIVE PUMPS ONLY: A low temperature fluid, such as a mixture of 50% ethylene or propylene glycol / 50% distilled water, or equivalent, must be used under all operating conditions.



**CAUTION:** Always select a fluid that is compatible with the Chiller's wetted parts (brass, stainless steel, polyethylene, EPDM rubber, and nylon).



**NOTE:** For storage purposes, a very small amount (below 25mL) of laboratory grade propylene glycol is added to the unit to avoid freezing damage to the pump. While this small amount will have no impact when mixed with other fluids, please refer to Routine Maintenance, Pump Drain for information on draining the pump.



**WARNING:** Do not use the following fluids:

- Automotive antifreeze with additives\*\*
- Hard tap water\*\*
- Deionized water with a specific resistance > 1 meg ohm (except units with the DI water compatible plumbing)
- Any flammable fluids
- Concentrations of acids or bases
- Solutions with halides: chlorides, fluorides, bromides, iodides or sulfur
- Bleach (Sodium Hypochlorite)
- Solutions with chromates or chromium salts
- Glycerin
- Syltherm fluids
- \*\* At temperatures above 40°C, additives or mineral deposits can adhere to the heater. If deposits are allowed to build up, the heater may overheat and fail. Higher temperatures and higher concentrations of additives can hasten deposit build up.

Recommended Fluids

PolyScience recommends the following fluids be used with Chillers. Always verify fluid compatibility with the application in which the chiller will be used and all wetted parts.

Fluid	Temperature Range	Recommended Maintenance
polyclear MIX 30 (distilled water plus clarifier)	+15° to +80°C (+59° to +176°F)	Verify fluid level monthly or more frequently per application needs. Replace fluid every 3 months.
polycool MIX -25 (50/50 mix distilled water and ethylene glycol)	-25° to +80°C (-13° to +176°F)	

Fluid Compatibility Table

Fluid	Material of Construction					
	Buna N Tubing	Viton® Tubing	Braided Teflon® Tubing	Nylon Fittings	Brass Fittings	Stainless Steel Fittings
polycool MIX -25 (50/50 premix of distilled water and ethylene glycol)	✓	✓	✓	✓	✓	✓
polyclear MIX 30 (distilled water plus clarifier)	✓	✓	✓	✓	✓	✓
polycool EG -25 concentratr (ethylene glycol)	✓	✓	✓	✓	✓	✓
polycool PG -20 concentrate (propylene glycol)	✓	✓	✓	✓	✓	✓
✓ = compatible						

The most common and acceptable coolant is a mixture of 50% distilled water and 50% ethylene glycol (laboratory grade), such as premix polycool MIX -25. This fluid mix will provide the best results for set points between -25° and +80°C (-13° and +176°F). Ethylene glycol helps lubricate pump seals and protects against freezing (the fluid temperature inside the Chiller may be below freezing even if the temperature at the outlet is over 0°C / +32°F).

PolyScience offers ethylene glycol (polycool EG -25) and propylene glycol (polycool PG -20) that can be mixed with an equal volume of distilled water to create a 50/50 water/glycol mix. Also available is a fluid clarifier to control inanimate organic particles (polyclean CLARIFIER).

### Filling the Reservoir

Remove the filler cap from the reservoir and, using a funnel, add fluid until it reaches the MAX line on the reservoir's fluid level gauge. Once the reservoir is full, remove the funnel but do not replace the cap at this time.

### Electrical Power

Plug the Chiller's power cord into an appropriate electrical outlet.

Place the Circuit Breaker/Power Switch on the rear of the instrument enclosure in the "On" position. Three decimal points will appear on the Temperature display; two decimal points will appear on the pressure/flow rate display.



### Starting Process Fluid Flow

Press the Power Button on the front panel. The system startup sequence will begin and proceed as follows:

1. The pump will turn on and fluid will begin circulating through the system. The set point temperature will appear briefly on the Temperature display; after a few seconds, it will be replaced by the actual fluid temperature. Fifteen to twenty seconds after power up, the compressor will begin operating.



**NOTE:** When adding fluid to the unit for the first time, prime the pump by pressing the Power Button "On" and letting the Chiller run for 3 seconds and then pressing the Power Button again to turn power "OFF". Repeat this "On" and "Off" procedure three times.

2. Check for leaks.
3. With the pump running, the reservoir's fluid level will drop as the process and/or process cooling lines fill with fluid. Do not let the fluid level drop below the minimum indicator, as air may get trapped in the system and damage the pump. Add fluid as follows:
4. **Closed Systems:** Slowly add fluid to the reservoir until the liquid level remains stable and over the minimum mark.
5. **Open Bath Systems:**
  - A. Set the flow alarm to at least 4 LPM (see "Minimum Flow Rate")
  - B. Open the inlet and outlet valves on the Chiller; the suction created by the pump should begin drawing fluid through the inlet tubing into the Chiller reservoir.
  - C. Once flow is established (no air bubbles in inlet tubing), close the inlet and outlet valves and turn the Chiller "Off".
  - D. Remove the reservoir cap and check the level of the fluid in the reservoir. Add coolant until it is leveled with the top of the filler neck.



**CAUTION:** Always close the inlet and outlet valves before turning power to the Chiller "Off" or removing the reservoir cap to prevent the external reservoir from flooding the Chiller.

- E. Replace the reservoir cap, open the inlet and outlet valves, and restart the Chiller.
- F. Observe the liquid level in the external reservoir; adjust the valve on the Chiller outlet as required to maintain a stable fluid level.



**CAUTION:** When running an open loop system for extended periods, the fluid level in the Chiller reservoir should be checked periodically to avoid low fluid conditions.

To check the reservoir fluid level, close the inlet and outlet valves, turn the Chiller "Off", and remove the reservoir cap. Slowly open the inlet and outlet valves and allow fluid to drain from the external reservoir into the Chiller reservoir. Close the valves when the fluid level within the Chiller reservoir reaches the top of the filler neck. Add fluid to the external reservoir as required. Replace the reservoir cap, open the inlet and outlet valves, and turn the Chiller back on.

## Normal Operation



**NOTE:** The Chiller incorporates a special "lockout" feature that can be enabled to prevent unauthorized or accidental set point and other operational changes. This feature is described in detail under "Enabling and Disabling the Local Lockout." It should not be enabled until all operational parameters have been set.

## Selecting the Temperature Unit (°C or °F)

The LEDs adjacent to the Temperature Display indicate the unit (°C or °F) used for temperature displays. To change from °C to °F or vice versa, proceed as follows:

**To change to °F** — Place the Circuit Breaker/Power Switch on the rear of the instrument in the "Off" position. Press and hold the Units/Menu Select Button while returning the Circuit Breaker/Power Switch to the "On" position.

**To change to °C** — Place the Circuit Breaker/Power Switch on the rear of the instrument in the "Off" position. Press and hold the Power Button on the front panel while returning the Circuit Breaker/Power Switch to the "On" position.



**CAUTION:** All user settings, except baud rate and calibration offset, return to the original factory defaults when the temperature unit is changed. The Chiller's temperature set point and various alarm settings should be reset to the desired values.

## Displaying and Adjusting the Set Point

Press the Select/Set Knob on the front panel. The current set point temperature will be displayed, and the decimal point at the bottom right of the display will flash, indicating that the temperature can be changed.

Rotate the Select/Set Knob until the desired set point temperature is displayed. The setting is accepted after the Set key is pressed a second time or automatically after a few seconds of inactivity.

When the set point is 20.0°C greater than the fluid temperature, the compressor and fan turn off. When the fluid temperature has risen to 5.0°C below the set point, the compressor and fan (enabled up to 50°C) will turn on and will remain on. If the set point is greater than the Auto-Refrigeration Temperature Set Point by 2°C, the compressor and fan will remain off. See "*Setting Operational Parameters, Auto-Refrigeration Temperature*".



**NOTE:** Temperature set point cannot be displayed or changed when the optional ambient temperature tracking feature is installed and enabled. See "*Displaying and Adjusting the Ambient Tracking Offset*" below and "*Setting Operational Parameters, Remote Probe*".

## Displaying and Adjusting the Ambient Tracking Offset



**NOTE:** Ambient tracking is an optional function that may or may not be available on your Chiller. It permits you to control fluid temperature based on room or machine temperature plus or minus a user-adjustable offset temperature.

When the optional ambient tracking probe is installed and enabled (AtC, see "*Setting Operational Parameters, Remote Probe*"), the ambient tracking offset rather than the set point temperature is displayed when the Select/Set Knob on the front panel is pressed.

To change the displayed offset value, rotate the Select/Set Knob until the desired offset value is displayed. An offset value from -5.0°C to +5.0°C (-9.0° to +9.0°F) may be entered. The setting is accepted after the Select/Set knob is pressed a second time or automatically after a few seconds of inactivity.



## Displaying and Adjusting the Remote Control Temperature



**NOTE:** Remote temperature control is an optional function that may or may not be available on your Chiller. It permits you to control cooling based on the temperature of an external process.

When the optional remote control external probe is installed and enabled (rP, see *Setting Operational Parameters, Remote Probe*), the external temperature set point is displayed when the Select/Set knob on the front panel is pressed.

To change the external temperature set point, press and then rotate the Select/Set knob until the desired set point temperature is displayed. The setting is accepted after the Select/Set knob is pressed a second time or automatically after a few seconds of inactivity.

## Selecting the Pressure / Flow Rate Display and Units

The Chiller can be set up to display either fluid pressure (in PSI or kPa) or if fitted with flow sensor flow rate in GPM (Option E) or lpm (Option M). Pressing the Units/Menu Select button briefly toggles through the available selections.



**NOTE:** If there is no flow sensor fitted, the display will show “- -” when Option E or Option M is selected.



**NOTE:** The flow rate readout is intended as a reference only. If accurate flow readings are required, an external flow meter is recommended.



**NOTE:** Metric pressure reading output is displayed in kPA and must be multiplied by 1000 for Pa.

## Selecting the Internal / External Temperature Display



**NOTE:** This section applies only when the ambient tracking probe or remote temperature control is installed and enabled. It allows the user to check or continuously display either the Chiller’s internal outlet fluid temperature or the external ambient/process temperature.

When the ambient tracking probe is selected (AtC, see “*Setting Operational Parameters, Remote Probe*”), the Chiller normally displays the internal outlet fluid temperature. To display the external ambient temperature, press and release the Units/Menu Select button until P2 appears on the pressure/flow rate display.

When the remote temperature control probe is selected (rPC, see “*Setting Operational Parameters, Remote Probe*”), the Chiller normally displays the external process temperature. To display the internal outlet fluid temperature, press and release the Units/Menu Select button until P1 appears on the pressure/flow rate display.



**NOTE:** P1 or P2 will remain on the pressure/flow rate display until the Units/Menu Select button is pressed and released. The displayed temperature will revert to the default condition (internal temperature for the ambient probe, external temperature for the remote temperature control probe).

## Setting Operational Parameters

The Chiller's various operational parameters, such as temperature, flow rate, and pressure alarm values, are all user-adjustable. They are accessed by pressing and holding the Units/Menu Button until HL appears on the pressure/flow rate display. Pressing and releasing the Units/Menu Button once HL appears allows you to scroll through the various parameters; rotating the Select/Set knob allows you to change the displayed setting. You can accept the displayed value by either pressing the Select/Set knob or allowing the display to timeout.

Menu Item	Description	Reset by Unit Change (°C -°F)	Choice/Ranges / Comments	Default Setting
HL	High Temperature Limit Alarm Set Point	Yes	+15°C to 71°C / 58° to 159°F	71°C 159°F
LL	Low Temperature Limit Alarm Set Point	Yes	-46°C to +14°C / -50° to 58°F	-46°C -50°F
HA	High Ambient Temperature Alarm Set Point	Yes	+30° to 71°C. Always displayed and set in °C.	50°C
FP w/psi LED lit	Maximum Fluid Pressure Alarm Set Point	Yes	40 to 100 PSI	100 PSI
FP w/kPa LED lit	Maximum Fluid Pressure Alarm Set Point	Yes	280 to 690 kPa	680 kPa
FL w/Option E LED lit	Minimum Flow Rate Alarm Set Point	Yes	0 or 0.8 to 2.0 GPM	0.0 GPM
FL w/Option M LED lit	Minimum Flow Rate Alarm Set Point	Yes	0 or 3 to 8 LPM	0.0 LPM
Sd	Establishes the cooling and heating rate by setting a desired differential between the measured internal and external temperature.	Yes	4°C to 20°C Always displayed and set in °C NOTE: Sd is displayed only if the optional remote temperature control probe is installed.	5°C
AF	Auto-Refrigeration Temperature Set Point	No	+20° to 50°C Always displayed/set in °C.	40°C
rP	External temperature probe status	No	n-A (the remote probe is not available) nEP (the remote probe is not plugged in) NO (the remote probe is disabled) AtC (ambient temperature control probe enabled) rPC (remote temperature control probe enabled)	n-A
°1	Internal Probe Calibration Offset	No	±2.9°C. Always displayed/set in °C. Special access procedure required. See <i>Internal Calibration Offset</i>	0.0°C
°2	External Probe Calibration Offset (only appears if a second probe is connected)	No	±2.9°C. Always displayed/set in °C. Special access procedure required. See <i>External Calibration Offset</i>	0.0°C
FC	Flow Rate Calibration	No	0.2 to 50.0	6.28
PC	RS232 Baud Rate	No	00, 24, 48, 96, 192. Represents baud rates of 0 (no communication), 2400, 4800, 9600, and 19200.	96

You can adjust the following settings for your particular application or simply accept the default values.

### High Temperature Limit (HL)

This menu item serves two functions. First, it establishes the maximum allowable set point temperature and thus helps prevent an operator from inadvertently selecting a temperature set point above a pre-established value. Secondly, it serves as a high temperature alarm, automatically activating both audio and visual alarm indicators if the measured fluid temperature reaches the HL setting. This also causes the compressor, heater, fan, and pump to turn off.

To change the high limit value, rotate the Select/Set knob until the desired value is displayed.

HL		71.0	
----	---	------	---

### Low Temperature Limit (LL)

This menu item also serves a dual function. First, it establishes the minimum allowable set point temperature and thus helps prevent an operator from inadvertently selecting a temperature set point below a pre-established value. Secondly, it serves as a low temperature alarm, automatically activating both audio and visual alarm indicators if the measured fluid temperature drops to the LL setting. This also causes the compressor, heater, fan, and pump to turn off.

To change the low limit value, rotate the Select/Set knob until the desired value is displayed.

LL		-46.0	
----	---	-------	---

### High Ambient Temperature Limit (HA)

	<b>NOTE:</b> This value is always set in °C.
---	--

This menu item protects the Chiller from overheating due to a high ambient temperature. Should the ambient temperature rise above the limit value, the audio and visual alarms will activate, and the compressor, heater, fan, and pump will turn off.

To change the high ambient temperature value, rotate the Select/Set knob until the desired value is displayed on the temperature readout.

HA		50	
----	---	----	---



### Maximum Fluid Pressure (FP)

This is the maximum allowable fluid pressure and can be set in either PSI or kPa (the LED adjacent to the display indicates the active unit of measure). Should the fluid pressure rise above the maximum fluid pressure value, the audio and visual alarms will activate and the compressor, heater, fan, and pump will turn off.

To change the fluid pressure limit value, rotate the Select/Set knob until the desired value is displayed on the temperature readout.

	<b>NOTE:</b> When FP first appears, the PSI LED will be lit. To view the FP value in kPa, press the Units/Menu Button again. The FP will remain on the display, and the kPa LED will light up.
---	--

FP	 PSI		100	
----	---	---	-----	---

FP	• kPa x 100		6.8	
----	-------------	---	-----	---

	<b>NOTE:</b> Chillers with positive displacement and turbine pumps also incorporate a built-in safety that automatically maintains fluid pressure below a valve-regulated pressure value. It maintains this maximum outlet pressure by diverting the flow of process fluid to the reservoir (i.e., begin internally recirculating the fluid). A maximum pressure value is set at the factory, but is user-adjustable. See “ <i>Adjusting the High Pressure Bypass Setting</i> ” for information on changing the maximum outlet pressure value.
---	--

### Minimum Flow Rate (FL)

	<b>CAUTION:</b> If flow rates are below 1.5 GPM (5.7 LPM), this feature is not recommended as nuisance alarms may result.
---	---

This is the minimum allowable flow rate and can be set in either GPM or LPM (the LED adjacent to the display indicates the active unit of measure). Should the fluid flow rate drop below the minimum value, the audio and visual alarms will activate, and the compressor, heater, fan, and pump will turn off.

To change the minimum flow rate value, rotate the Select/Set Knob until the desired flow rate value is displayed on the temperature readout.

With FL set to “0”, the flow alarm is disabled, and the chiller will continue to operate with the output flow blocked.

	<b>NOTE:</b> When FL first appears, the Option E LED will be lit, indicating the FL value is GPM. To view the FL value in LPM, press the Units/Menu Button again. The FL will remain on the display and the Option M (LPM) LED will light up.
---	---

FL	• Option E		0.0	
----	------------	---	-----	---

FL	• Option M		0.0	
----	------------	---	-----	---

### Maximum External / Internal Temperature Differential (Sd) (optional)

	<b>NOTE:</b> This menu item (Sd) is only applicable when the remote temperature control probe is installed and enabled.
---	---

This value helps establish the cooling/heating rate when the remote temperature control probe is being used. Maximum external/internal differential temperature values from 4° to 20°C may be entered. The higher the setting, the more rapidly the Chiller will achieve the external temperature set point. Low differential temperature settings minimize the amount of temperature overshoot/undershoot that occurs when the measured external temperature reaches the external set point temperature.

Sd			5.0	
----	--	---	-----	---

### Auto-Refrigeration Temperature (AF)

	<b>NOTE:</b> This value is always displayed/set in °C.
---	--

This menu item allows you to select the temperature at which refrigeration is deactivated. When the set point exceeds the auto-refrigeration temperature by more than 1.0°C, the refrigeration system (compressor and fan) are turned off.

To change the auto-refrigeration temperature, rotate the Select/Set knob until the desired value is displayed.



For example, when the Auto-Refrigeration value is set to 40.0°C, the refrigeration system (compressor and fan) will turn off when the fluid temperature is over 41.0°C.

### Remote Probe (rP)

	<b>NOTE:</b> If an external temperature probe is not installed, n-A will be displayed when this menu item is selected.
---	--

This menu item allows you to enable/disable the Chiller’s optional ambient temperature probe (AtC) or remote temperature control probe (rPC).

If you wish to operate the Chiller using the ambient tracking probe, rotate the Select/Set knob until AtC is displayed. When this setting is selected, the effective set point for the cooling fluid temperature will be the temperature sensed by the ambient tracking probe (this may be room or machine temperature) plus or minus an offset specified by the user (see “*Displaying and Adjusting the Ambient Tracking Offset*”).



If you wish to operate the Chiller using the remote temperature probe, rotate the Select/Set knob until rPC is displayed. When this setting is selected, the fluid temperature is controlled according to the temperature sensed by the external probe. The rate of cooling is controlled through the maximum differential temperature setting (Sd) (see “*Maximum External / Internal Temperature Differential*”).

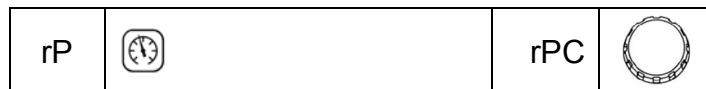

If you do not wish to operate the Chiller using either of these external probes, rotate the Select/Set knob until NO is displayed.

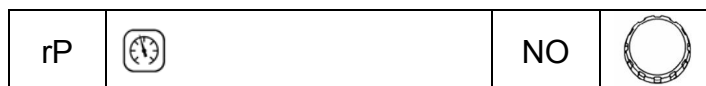

### Internal Calibration Offset (°C1)



**CAUTION:** To prevent the operator from accidentally changing the calibration offset, a special keystroke sequence is required to access this function.

This menu item allows you to adjust the Chiller's internal temperature reading to match that of a traceable standard. It allows you to offset the displayed temperature value by as much as  $\pm 2.9^{\circ}\text{C}$ .



**NOTE:** Calibration offset values are always set and displayed in  $^{\circ}\text{C}$ .

1. Press and hold the Units/Menu Button until HL appears on the display.
2. Press and release the Units/Menu Button until rP appears on the display.
3. Press and hold the Units/Menu Button.
4. While holding the Units/Menu Button, press and release the Select/Set knob.
5. When CL1 appears on the temperature readout, release the Units/Menu Button. The current calibration offset value will appear on the temperature readout and alternate with the fluid temperature reading (enabling you to simultaneously adjust the offset and see the effect on the temperature).
6. Rotate the Select/Set knob until the desired calibration offset is displayed. Press the Select/Set knob or simply allow the display to time out to accept the displayed value.



### External Calibration Offset (°C2)



**CAUTION:** To prevent the operator from accidentally changing the calibration offset, a special keystroke sequence is required to access this function.

This menu item allows you to adjust the Chiller's external temperature reading to match that of a traceable standard. It allows you to offset the displayed temperature value by as much as  $\pm 2.9^{\circ}\text{C}$ . It appears only if the external temperature probe is installed.



**NOTE:** Calibration offset values are always set and displayed in  $^{\circ}\text{C}$ .

1. Press and hold the Units/Menu Button until HL appears on the display.
2. Press and release the Units/Menu Button until °C1 appears on the display.
3. Press and hold the Units/Menu Button.
4. While holding the Units/Menu Button, press and release the Select/Set knob.
5. When C2 appears on the temperature readout, release the Units/Menu Button. The current calibration offset value will appear on the temperature readout and alternate with the fluid temperature reading (enabling you to simultaneously adjust the offset and see the effect on the temperature).
6. Rotate the Select/Set knob until the desired calibration offset is displayed. Press the Select/Set knob or simply allow the display to time out to accept the displayed value.



### Flow Rate Calibration (Fc)

There may be minor differences between the Chiller's displayed flow rate and the actual flow rate as determined by a certified flow rate measurement device. The Chiller's displayed flow rate reading can be adjusted to match an external device by changing the flow rate gain coefficient setting as follows:

1. Press and hold the Units/Menu Button until HL appears on the display.
2. Press and release the Units/Menu Button until °C1 (°C2 if the Chiller is equipped with an external temperature probe) appears on the display.
3. Press and hold the Units/Menu Button; Fc will appear on the pressure/flow rate display.
4. While holding the Units/Menu Button, press and release the Select/Set Knob.
5. When CLF appears on the temperature readout, release the Units/Menu Button. The current gain coefficient value will appear on the temperature readout.
6. Rotate the Select/Set Knob until the desired flow rate is displayed on the flow readout. Press the Select/Set Knob or simply allow the display to time out to accept the displayed value.

Fc		6.28	
----	---	------	---

### Baud Rate (PC)

This menu item allows you to establish the baud rate for serial communication. Allowable settings are 0 (no serial communication), 24 (2400 baud), 48 (4800 baud), 96 (9600 baud), 192 (19200 baud).

To change the displayed setting, rotate the Select/Set knob until the desired baud rate is displayed.

Press the Select/Set Knob or allow the display to time out to accept the displayed value.

PC		96	
----	---	----	---

## Display, Alarm and Error Messages

When certain conditions are detected, a message code flashes on the display and the local audio alarm sounds. Depending on the nature of the condition, power to various systems components, such as the compressor, heater, fan, and pump, is removed. When the condition is rectified, push the front panel power button or turn the circuit breaker off then on to clear the fault or error.

Message Code	Description	Action Required
<b>EAF</b>	Rear panel high ambient temperature  (select models only)	Warning - The ambient temperature is higher than the set ambient limit. The display alternates between EHA and the fluid temperature; the unit continues normal operation. If this lasts for more than 5 seconds, Fault 17 occurs.  Lower ambient temperature.
<b>E C</b>	External remote control active, Chiller in standby (for units with remote control by 12 VDC option)	Normal — Unit idle until remotely activated.
<b>E-C</b>	External remote control active, Chiller in standby  Only appears when Chiller is equipped for remote control using a dry contact	Normal — Unit idle until remotely activated.
<b>EFL</b>	Low fluid level — units with fluid level float switch.  or  Fluid flow too low — units with magnetic drive centrifugal pump.	Warning / Alarm — Fluid level or flow switch is open. Alarm will sound once every 8 seconds for 5 occurrences. If problem has not been corrected after 40 seconds, Fault 05 occurs. Add fluid to the reservoir.  Remove restrictions to flow.
<b>EHA</b>	Front panel high ambient temperature warning.	Warning - The ambient temperature is higher than the set ambient limit. The display alternates between EHA and the fluid temperature; the unit continues normal operation. If the ambient temperature stays over 5°C above the high ambient limit for more than 5 seconds, Fault 16 occurs.  Lower ambient temperature or raise temperature limit.
<b>EHL</b>	High temperature set point warning	Warning — The temperature set point is higher than the high temperature limit value. The display alternates between EHL and the fluid temperature; the unit continues normal operation. The high temperature limit alarm will be activated if the fluid temperature exceeds the HL value for 25 consecutive seconds.  Lower temperature set point or increase high limit value.
<b>ELL</b>	Low temperature set point warning	Warning — The temperature set point is lower than the low temperature limit value. The display alternates between ELL and the fluid temperature; the unit continues normal operation. The low temperature limit alarm will be activated if the fluid temperature exceeds the LL value for 25 consecutive seconds.  Increase temperature set point or decrease low limit value.
<b>LLO</b>	Local Lockout	Normal — Indicates that Local Lockout feature (see <i>Enabling / Disabling the Local Lockout</i> ) is enabled. Appears momentarily when Select/Set knob is pressed to view/change set point value.
<b>CAn</b>	Cancel Local Lockout	Normal — Indicates the Local Lockout feature (see <i>Enabling / Disabling the Local Lockout</i> ) has been disabled. Appears momentarily when Local Lockout status is changed from enabled (LLO) to disabled.



Message Code	Description	Action Required
<b>LO-H2O</b>	No fluid flow and no fluid pressure	Warning — LO is displayed alternately with H2O and fluid temperature if the fluid pressure is zero (0.0) or if the fluid flow is less than the low flow limit. If either error lasts for more than 10 seconds, Fault 7 occurs.

If a fault should occur, the left display will show Ft, and the right display will show one of the fault codes shown below.

Fault Code	Description	Action Required
<b>01</b>	Factory reserved	None.
<b>02</b>	Low limit temperature alarm	Alarm — Process fluid temperature is below the low temperature limit value for more than 25 seconds. Compressor, heater, and fan are turned off; pump remains on.  To clear the fault, turn the unit off then on using the panel power button, and decrease the LL value.
<b>03</b>	High limit temperature alarm	Alarm — Process fluid temperature is above the high temperature limit value for more than 25 seconds. Compressor, heater, and fan are turned off; pump remains on.  To clear the fault, turn the unit off then on using the panel power button, and increase the HL value.
<b>04</b>	Over-temperature protection alarm	Alarm — Process fluid temperature is above Chiller's factory set high temperature safety cutoff. Heater, compressor, and fan turned off; pump remains on.  Lower process temperature.
<b>05</b>	Low liquid level alarm (select models only)	Delayed Alarm — Activated when the liquid level in the reservoir falls below an acceptable level for over 40 seconds. Compressor, heater, fan, and pump are turned off.  Add fluid to reservoir.
<b>06</b>	High bath temperature alarm	Alarm — Fluid temperature has exceeded 82°C (180°F) for more than 5 seconds. Compressor, heater, fan, and pump are turned off.  Lower fluid temperature.
<b>07</b>	Low flow alarm	Alarm — Flow rate has dropped below minimum flow rate setting for more than 10 seconds. Compressor, heater, fan, and pump are turned off. Note: Disabled during first 2 minutes of operation.  Correct cause of low flow rate or decrease minimum flow rate setting.
<b>08</b>	High pressure alarm	Alarm — Fluid outlet pressure has exceeded high-pressure limit value for over 10 seconds. Compressor, heater, fan, and pump are turned off.  Decrease outlet pressure by removing blockage or increase high-pressure limit value.
<b>09</b>	System fault	Fault — One or more settings are out of range. Compressor, heater, fan, and pump are turned off. Contact service representative for corrective action.

<b>Fault Code</b>	<b>Description</b>	<b>Action Required</b>
<b>10</b>	Electronic power component fault (Triac)	Fault — Heater triac has failed for more than 10 seconds. Compressor, heater, fan, and pump are turned off. Contact supplier.
<b>11</b>	Internal probe fault	Fault — Main temperature control probe has failed for more than 4 seconds. Compressor, heater, fan, and pump are turned off. Contact supplier.
<b>12</b>	External temperature probe fault (select models only)	Fault — External temperature control probe has failed for more than 4 seconds. Compressor, heater, fan, and pump are turned off. Replace ambient tracking probe or operate instrument using internal temperature probe. Contact supplier if fault persists.
<b>13</b>	Communications fault	Fault — Internal electronics failure. Compressor, heater, fan, and pump are turned off. Contact supplier.
<b>14</b>	ADC fault, internal probe	Fault — ADC for internal temperature probe is reading faulty values. Compressor, heater, fan, and pump are turned off. Contact supplier.
<b>15</b>	ADC fault, external probe	Fault — ADC for external temperature probe is reading faulty values. Compressor, heater, fan, and pump are turned off. Contact supplier.
<b>16</b>	Front panel high ambient temperature alarm	Alarm — Ambient temperature at front panel has exceeded the high ambient temperature limit exceeds by more than 5°C for more than 5 seconds. Compressor, heater, fan, and pump are turned off.  Lower ambient temperature or increase high ambient temperature limit value. See <i>High Ambient Temperature Limit</i>
<b>17</b>	Rear panel high ambient temperature alarm (select models only)	Alarm — Ambient temperature at rear panel has exceeded the factory-set high ambient limit for more than 5 seconds. Compressor, heater, fan, and pump turned off.  Lower ambient temperature.

## Adjusting the High Pressure Bypass Setting

Chiller with positive displacement or turbine pumps incorporate an automatic safety to maintain outlet pressure below a valve-regulated pressure. This valve is adjustable and is located inside the Chiller housing.



**WARNING:** There are exposed fan blades inside the Chiller housing. Exercise extreme care when accessing or adjusting any interior components.



**WARNING:** Hazardous voltages are present.

To access the high-pressure bypass valve, remove the two screws at the upper left and right corners of the Chiller's rear panel, slide the top panel back about 2-3 inches, and lift off. The regulator valve is located in the left rear corner of the unit.

The high-pressure bypass is adjusted as follows:

1. Set the low flow rate alarm value to zero (see *Setting Operational Parameters, Minimum Flow Rate*). This will prevent the unit from activating the flow alarm while you are adjusting the maximum pressure setting.
2. Completely block the Chiller's outlet flow. This should cause the outlet pressure to rise.
3. Set the Pressure/Flow Rate display to read either PSI or kPa.
4. Rotate the handle on the pressure valve until the desired maximum pressure setting is shown on the Pressure/Flow Rate display.
5. Reset the flow alarm value to the previous setting.
6. Return the Pressure/Flow Rate display to the previous setting.
7. Replace the top panel of the Chiller, being sure to secure the bayonet-style prongs on the front of the panel in the openings at the front of the unit. Reinsert the two screws that secure the top panel to the rear panel of the unit.

## Enabling / Disabling the Local Lockout

This feature is used to prevent unauthorized or accidental changes to set point and other operational values. When enabled, the values for the following functions can be displayed, but not changed:

- Temperature unit
- Temperature set point
- Ambient tracking offset
- Pressure / flow rate units

To enable the local lockout, press and hold the Select/Set Knob until LLO is displayed (approximately 5 seconds). Once enabled, LLO will appear momentarily when the Select/Set Knob is pressed to display the set point.

To disable the local lockout, press and hold the Select/Set knob until CAn appears momentarily as local lockout status changes from enabled (LLO) to disabled (approximately 5 seconds).



**CAUTION:** The Local Lockout feature does not prevent set point changes entered via the RS232 interface.

# Routine Maintenance and Troubleshooting

## Routine Maintenance

The Chiller is designed to require a minimum of periodic maintenance.

## Pump Lubrication



**WARNING:** Hazardous voltages are present. Turn all power to the Chiller OFF and unplug the power cord from the electrical outlet.

Only Chillers equipped with a Standard Magnetic Drive Centrifugal Pump require lubrication. Chillers equipped with Turbine or Positive Displacement Pumps do not require lubrication.

### Standard Magnetic Drive Centrifugal Pump

When operating continuously, this pump should be oiled every six (6) months with SAE 20 oil. The pump incorporates two oil ports on the front and back of the pump motor for this purpose.

To access the pump:

1. Turn both power switches off and unplug the power cord.
2. Remove the top panel of the housing (held in place with two bolts at the upper left and right corners of the rear panel).
3. Remove the housing's side panels by lifting them out of the housing frame.



### Pump Drain

Only Chillers equipped with a Standard Magnetic Drive Centrifugal or Turbine can be drained. Chillers equipped with a Positive Displacement Pump cannot be drained.



**WARNING:** Hazardous voltages are present. Turn all power to the Chiller OFF and unplug the power cord from the electrical outlet.

To access and drain the pump:

1. Turn both power switches off and unplug the power cord.
2. Remove the top panel of the housing (held in place with two bolts at the upper left and right corners of the rear panel).
3. Remove the housing's side panels by lifting them out of the housing frame.
4. Gently pull the insulation on the pump head up to gain access to the either the drain screw (Turbine Pump) or four wing nuts (Standard Magnetic Drive Centrifugal Pump).

Drain Screw

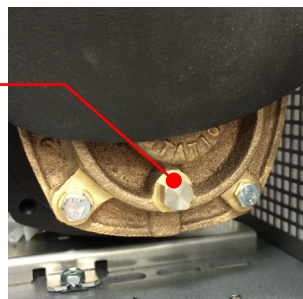

Turbine Pump

Wing Nuts  
(4 total)

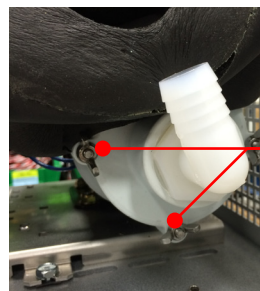

Standard Magnetic Drive Centrifugal Pump

5. Place a small container beneath the drain port (Turbine Pump) or pump outlet (Standard Magnetic Drive Centrifugal Pump) and the loosen the drain screw or wing nuts.
6. Once all fluid in the pump has been drained, re-tighten the drain screw or wing nuts.

### **Condenser, Air Vents and Reusable Filter (Air-Cooled Models only)**

To keep the system operating at optimum cooling capacity, the condenser, the air vents, and reusable filter should be kept free of dust and dirt. They should be checked on a regular basis and cleaned as required.

The reusable filter is easily accessed from either the left or right side of the unit. Use a mild detergent and water solution to wash off any accumulated dust and dirt. Rinse and dry thoroughly before reinstalling.

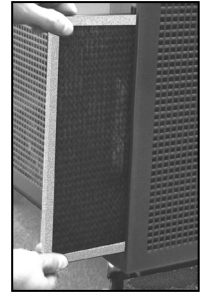

### **Fluid Filter**

A removable, highly efficient fluid filter is integrated into the fluid reservoir. To remove it for cleaning, simply remove the reservoir cap and lift the filter out of the reservoir. Rinse off accumulated particulate matter and reinstall.

### **Fluid Level**

The fluid level gauge on the rear of the Chiller should be periodically checked to determine if the fluid level needs to be topped off. Generally, fluid should be added whenever the level in the reservoir is at or near the “Low” gauge mark.

### **Temperature Calibration**

At times, there may be a minor temperature difference between the Chiller’s displayed temperature and the actual temperature as determined by a certified temperature measurement device. There may also be situations where you want the displayed temperature to match a particular value to have standardization between different instruments. These adjustments can be performed using the Chiller’s internal and/or external temperature calibration offset functions. See “*Setting Operational Parameters, Remote Probe and Internal Calibration Offset*”.

## Troubleshooting

	<p>Many problems can be resolved by restoring the factory defaults. If this solves the problem, be careful when restoring your operational settings in order not to repeat the problem.</p> <p>To restore the factory default settings:</p> <ol style="list-style-type: none"> <li>1. Place the Power Switch/Circuit Breaker on the rear of the unit in the OFF position.</li> <li>2. Press and hold the Power Button on the front panel while returning the Power Switch/Circuit Breaker to the ON position.</li> </ol>
---	--

	<p><b>WARNING:</b> Refer servicing to qualified service personnel.</p>
---	--

	<p><b>WARNING:</b> When electrical power is ON, dangerous voltages exist within chassis components. Use extreme care when measuring voltages on live circuits.</p>
---	--

Problem	Possible Causes	Corrective Action
Unit does not run (digital displays blank)	No power to unit	Check that the electrical cord is secure and connected to an operating electrical outlet.  Check that Power Switch / Circuit Breaker on rear of unit is ON.
Unit does not run (three decimal points appear on temperature display, two decimal points on pressure/flow rate display)	Unit in Standby mode	Press Power Button on front panel.
No fluid circulation	Insufficient fluid in reservoir Blockage in circulating system Pump is not operating	Add fluid to reservoir. Remove blockage. Replace pump.
Insufficient circulation	Fluid viscosity too high External tubing diameter too small Restrictions in fluid lines Low line voltage	Replace with lower viscosity fluid. Replace with larger diameter tubing.  Check and correct as required. Check and correct as required.
Unit does not cool or cooling is insufficient	Dust build up on air filter or condenser (air-cooled models) Blocked air ventilation screens (air-cooled models) Facility water too warm (water-cooled models) Excessive heat load  Ambient air temperature too high Low or high line voltage Faulty temperature sensor	Clean air filter and/or condenser as required.  Remove blockages as required.  Lower temperature of facility water)  Check that heat load does not exceed capacity of chiller; correct as required.  Decrease ambient air temperature.  Check and correct as required.  Check the compressor upper, evaporator inlet and evaporator outlet temperature sensor readings (see "Diagnostic Mode"). If any of these temperature readings is $-50^{\circ}\text{C}$ , the sensor needs to be replaced.

Problem	Possible Causes	Corrective Action
Fault code 10 on display	Extreme electrical line interference Triac failure	Plug unit into another power source. If problem persists, triac has failed. Contact supplier.
Fault code 11 on display	Internal probe failure	Contact supplier
Fault code 12 on display	Loose external probe connection Faulty external temperature probe	Check and correct as required. Replace as required.  NOTE: Chiller may be operated using internal probe until problem is corrected.

## Diagnostic Mode

	<b>NOTE:</b> The Chiller must be set up to display temperature in °C in order to access the diagnostic mode.
---	--

The Chiller incorporates a Diagnostic mode, which displays important operational information that can aid in troubleshooting. To access the Diagnostic mode, place the Circuit Breaker/Power Switch in the “Off” position and then return it to the “On” position while pressing and holding the Select/Set Knob. The diagnostic menu appears on the Pressure/Flow Rate display; the current value for the diagnostic item appears on the temperature readout.

	<b>NOTE:</b> Diagnostic items are display values only; they cannot be changed..
--	---

Menu Item	Description
EC	External control control
Ut	Upper (head) temperature
Li	Percent of Line voltage
Ct	Chiller type (model)
Fb	Fuse bits (remote control voltage, contact closures, etc.)
EP	External probe temperature and “---“, displayed when external probe is not installed
03 (variable numeric value)	Fluid flow rate or pressure; Temperature display shows current fluid temperature
At	Ambient temperature at front panel

# Technical Information

## General Specifications (all Chillers)

Temperature Set Point Resolution	±0.1°C
Temperature Stability	±0.1°C
Temperature Units	°C or °F
Pressure Units	PSI or kPa
Pressure Display Resolution Pressure Display Accuracy	1 PSI / 6.9 kPa ±3.5% of full scale (100PSI)
Flow Rate Units	GPM or LPM
Flow Rate Display Resolution Flow Rate Display Accuracy	0.1 GPM / 1 LPM +/- 0.4 GPM / 1.5 LPM
Pump Inlet and Outlet	½ inch NPT

## Pump Performance

### Magnetic Drive Centrifugal Pump

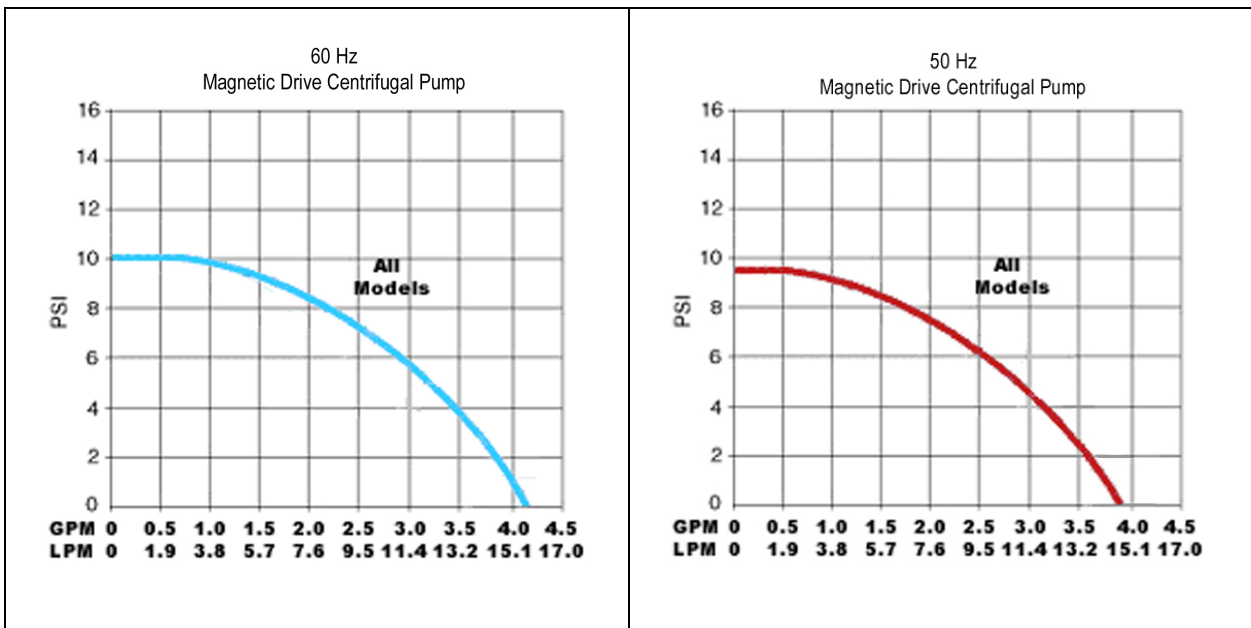



## Positive Displacement Pump

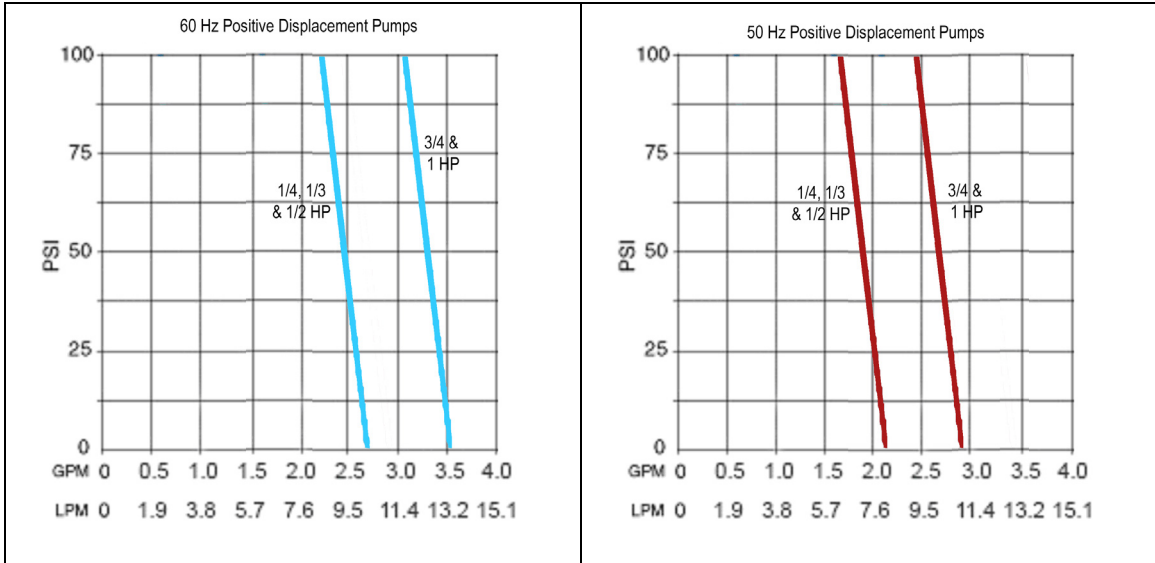

## Turbine Pump

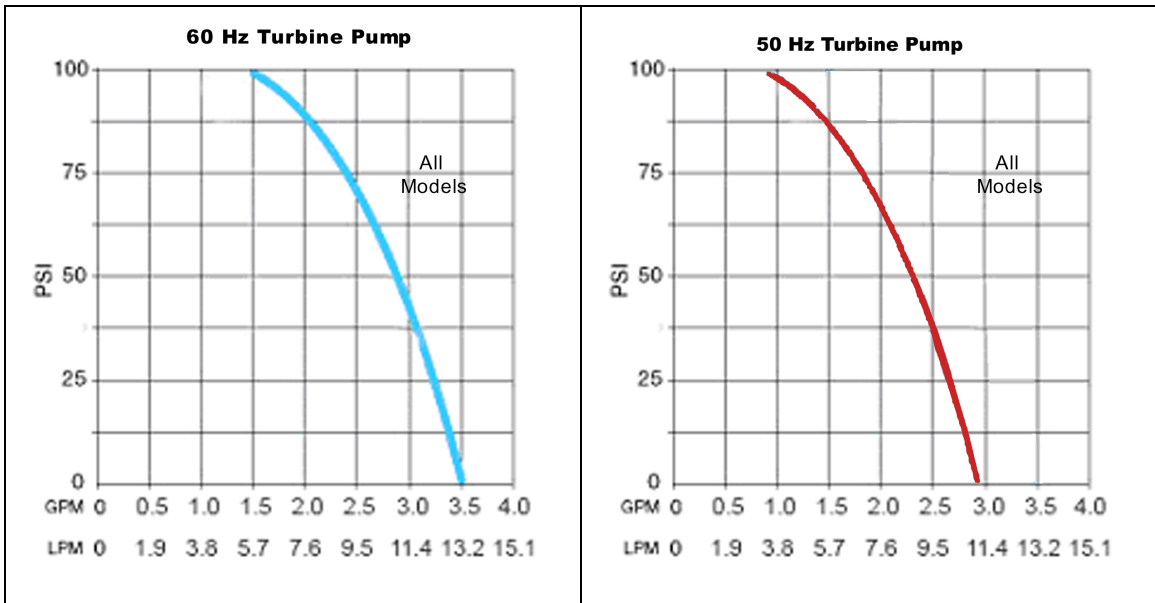

## Performance Specifications — 60Hz Chillers

### Air-Cooled 1/4-HP, 1/3-HP and 1/2-HP Chillers

<b>Magnetic Drive Centrifugal Pump (60Hz)</b>						
Model: Rfg = Refrigerating Only Rfg / Htg = Refrigerating & Heating						
<b>Model Type</b>	<b>Rfg</b>	<b>Rfg / Htg</b>	<b>Rfg</b>	<b>Rfg / Htg</b>	<b>Rfg</b>	<b>Rfg / Htg</b>
Operating Temperature	-10° to 40°C	-10° to 70°C	-10° to 40°C	-10° to 70°C	-10° to 40°C	-10° to 70°C
Cooling Temperature Range	-10° to 40°C	-10° to 50°C	-10° to 40°C	-10° to 50°C	-10° to 40°C	-10° to 50°C
Compressor	1/4 HP		1/3 HP		1/2 HP	
Cooling Capacity @ 20°C 10°C 0°C	950 watts 700 watts 300 watts	3244 BTU/hr 2391 BTU/hr 1025 BTU/hr	1430 watts 1000 watts 700 watts	4884 BTU/hr 3415 BTU/hr 2391 BTU/hr	1842 watts 1386 watts 870 watts	6291 BTU/hr 4733 BTU/hr 2971 BTU/hr
Pressure at 0 Flow Rate	10 psi / 69 kPa		10 psi / 69 kPa		10 psi / 69 kPa	
Flow Rate at 0 psi	4.1 gpm / 15.5 lpm		4.1 gpm / 15.5 lpm		4.1 gpm / 15.5 lpm	
Reservoir Capacity	1.1 gal / 4.2 liters		1.1 gal / 4.2 liters		1.1 gal / 4.2 liters	
Dimensions (L x W x H)	27.6 x 14.5 x 22.6 in. 70.2 x 36.8 x 57.5 cm.					
Shipping Weight	131 pounds 59.4 kg		143 pounds 64.8 kg		168 pounds 76.2 kg	
120 V, 60 Hz Chillers Volts Range	108 to 132V					
Amps	9.5A	10.0A	10.4A	10.7A	13.5A	13.8A

### Positive Displacement Pump (60Hz)

Model: Rfg = Refrigerating Only  
Rfg / Htg = Refrigerating & Heating

Model Type	Rfg	Rfg / Htg	Rfg P	Rfg / Htg	Rfg	Rfg / Htg
Operating Temperature	-10° to 40°C	-10°C to 70°C	-10° to 40°C	-10°C to 70°C	-10° to 40°C	-10° to 70°C
Cooling Temperature Range	-10° to 40°C	-10°C to 50°C	-10° to 40°C	-10°C to 50°C	-10° to 40°C	-10° to 50°C
Compressor	1/4 HP		1/3 HP		1/2 HP	
Cooling Capacity @ 20°C 10°C 0°C	850 watts 600 watts 400 watts	2902 BTU/hr 2049 BTU/hr 1366 BTU/hr	1400 watts 990 watts 530 watts	4781 BTU/hr 3381 BTU/hr 1819 BTU/hr	1742 watts 1286 watts 770 watts	5949 BTU/hr 4392 BTU/hr 2630 BTU/hr
Flow Rate @ 0 psi	2.6 gpm / 9.8 lpm		2.6 gpm / 9.8 lpm		2.6 gpm / 9.8 lpm	
Pump Pressure (adjustable)	20 to 100 psi 138 to 689 kPa		20 to 100 psi 138 to 689 kPa		20 to 100 psi 138 to 689 kPa	
Reservoir Capacity	1.1 gal / 4.2 liters		1.1 gal / 4.2 liters		1.1 gal / 4.2 liters	
Dimensions (L x W x H)	27.6 x 14.5 x 22.6 in. 70.2 x 36.8 x 57.5 cm.					
Shipping Weight	141 pounds 64 kg		153 pounds 69 kg		178 pounds 81 kg	
120 V, 60 Hz Chillers Volts Range	108 to 132V					
Amps	12.8A	13.1A	13.7A	14.1A	16.2A	16.6A

### Turbine Pump (60Hz)

Model: Rfg = Refrigerating Only  
Rfg / Htg = Refrigerating & Heating

Model Type	Rfg	Rfg / Htg	Rfg	Rfg / Htg	Rfg	Rfg / Htg
Operating Temperature	-10° to 40°C	-10°C to 70°C	-10° to 40°C	-10°C to 70°C	-10° to 40°C	-10°C to 70°C
Cooling Temperature Range	-10° to 40°C	-10°C to 50°C	-10° to 40°C	-10°C to 50°C	-10° to 40°C	-10°C to 50°C
Compressor	1/4 HP		1/3 HP		1/2 HP	
Cooling Capacity @ 20°C 10°C 0°C	850 watts 600 watts 400 watts	2902 BTU/hr 2049 BTU/hr 1366 BTU/hr	1400 watts 990 watts 530 watts	4781 BTU/hr 3381 BTU/hr 1819 BTU/hr	1742 watts 1286 watts 770 watts	5949 BTU/hr 4392 BTU/hr 2630 BTU/hr
Flow Rate @ 0 psi	3.5 gpm / 13.2 lpm		3.5 gpm / 13.2 lpm		3.5 gpm / 13.2 lpm	
Pump Pressure (adjustable)	20 to 90 psi 138 to 621 kPa		20 to 90 psi 138 to 621 kPa		20 to 90 psi 138 to 621 kPa	
Reservoir Capacity	1.1 gal / 4.2 liters		1.1 gal / 4.2 liters		1.1 gal / 4.2 liters	
Dimensions (L x W x H)	27.6 x 14.5 x 22.6 in. 70.2 x 36.8 x 57.5 cm.					
Shipping Weight	143 pounds 65 kg		156 pounds 71 kg		181 pounds 82 kg	
120 V, 60 Hz Chillers Volts Range	108 to 132V					
Amps	12.2A	12.5A	13.1A	13.5A	16.0A	16.4A

**Air-Cooled 3/4-HP and 1-HP Chillers**

<b>Magnetic Drive Centrifugal Pump (60Hz)</b>					
Model: Rfg = Refrigerating Only Rfg / Htg = Refrigerating & Heating					
<b>Model Type</b>		<b>Rfg</b>	<b>Rfg / Htg</b>	<b>Rfg</b>	<b>Rfg / Htg</b>
Operating Temperature		-10° to 40°C	-10° to 70°C	-10° to 40°C	-10 to 70°C
Compressor		3/4 HP		1 HP	
Cooling Capacity @	20°C 10°C 0°C	2350 watts 1550 watts 975 watts	8026 BTU/hr 5294 BTU/hr 3330 BTU/hr	2900 watts 1835 watts 1100 watts	9904 BTU/hr 6267 BTU/hr 3757 BTU/hr
Pressure at 0 Flow Rate		10 psi / 69 kPa		10 psi / 69 kPa	
Flow Rate at 0 psi		4.1 gpm / 15.5 lpm		4.1 gpm / 15.5 lpm	
Reservoir Capacity		1.1 gal / 4.2 liters		1.1 gal / 4.2 liters	
Dimensions (L x W x H)		27.6 x 14.5 x 22.6 in. 70.2 x 36.8 x 57.5 cm.			
Shipping Weight		187 pounds 84.8 kg		189 pounds 85.7 kg	
208-230 V, 60 Hz Volts Range		187 to 253V			
Amps		9.2A	9.5A	9.5A	9.8A

<b>Positive Displacement Pump (60Hz)</b>					
Model: Rfg = Refrigerating Only Rfg / Htg = Refrigerating & Heating					
<b>Model Type</b>		<b>Rfg</b>	<b>Rfg / Htg</b>	<b>Rfg</b>	<b>Rfg / Htg</b>
Operating Temperature		-10° to 40°C	-10° to 70°C	-10° to 40°C	-10° to 70°C
Compressor		3/4 HP		1 HP	
Cooling Capacity @	20°C 10°C 0°C	2300 watts 1550 watts 875 watts	7855 BTU/hr 5294 BTU/hr 2988 BTU/hr	2900 watts 1925 watts 1000 watts	9904 BTU/hr 6574 BTU/hr 3415 BTU/hr
Flow Rate @ 0 psi		3.5 gpm / 13.2 lpm		3.5 gpm / 13.2 lpm	
Pump Pressure (adjustable)		20 to 100 psi 138 to 689 kPa		20 to 100 psi 138 to 689 kPa	
Reservoir Capacity		1.1 gal / 4.2 liters		1.1 gal / 4.2 liters	
Dimensions (L x W x H)		27.6 x 14.5 x 22.6 in. 70.2 x 36.8 x 57.5 cm.			
Shipping Weight		197 pounds 89 kg		199 pounds 90 kg	
208-230 V, 60 Hz Volts Range		187 to 253V			
Amps		11.9A	12.2A	12.2A	12.5A

<b>Turbine Pump (60Hz)</b>					
Model: Rfg = Refrigerating Only Rfg / Htg = Refrigerating & Heating					
Model Type		Rfg	Rfg / Htg	Rfg	Rfg / Htg
Operating Temperature		-10° to 40°C	-10° to 70°C	-10° to 40°C	-10° to 70°C
Compressor		3/4 HP		1 HP	
Cooling Capacity @	20°C 10°C 0°C	2300 watts 1550 watts 875 watts	7855 BTU/hr 5294 BTU/hr 2988 BTU/hr	2900 watts 1925 watts 1000 watts	9904 BTU/hr 6574 BTU/hr 3415 BTU/hr
Flow Rate @ 0 psi		3.5 gpm / 13.2 lpm		3.5 gpm / 13.2 lpm	
Pump Pressure (adjustable)		20 to 90 psi 138 to 621 kPa		20 to 90 psi 138 to 621 kPa	
Reservoir Capacity		1.1 gal / 4.2 liters		1.1 gal / 4.2 liters	
Dimensions (L x W x H)		27.6 x 14.5 x 22.6 in. 70.2 x 36.8 x 57.5 cm.			
Shipping Weight		197 pounds 89 kg		199 pounds 90 kg	
208-230 V, 60 Hz Volts Range		187 to 253V			
Amps		11.9A	12.2A	12.2A	12.5A

### Water-Cooled 3/4-HP Chillers

<b>Turbine Pump (230 VAC)</b>		
Model: Rfg = Refrigerating Only Rfg / Htg = Refrigerating & Heating		
Model Type		Rfg / Htg
Operating Temperature		-10°C to 70°C
Cooling Temperature Range		-10°C to 50°C
Compressor		1/2 HP
Cooling Capacity	230 V, 60 Hz 200 V, 50 Hz	1850 watts @ 20°C fluid temperature 1150 watts @ 20°C fluid temperature
Flow Rate @ 0 psi		3.5 gpm / 13.2 lpm
Pump Pressure (adjustable)		20 to 90 psi 138 to 621 kPa
Reservoir Capacity		1.1 gal / 4.2 liters
Dimensions (L x W x H)		27.6 x 14.5 x 22.6 in. 70.2 x 36.8 x 57.5 cm.
Shipping Weight		187 pounds / 84.8 kg
Facility Water Requirement		Temperature Range: 8° to 30°C Pressure: 20 PSI minimum; 100 PSI maximum Flow: 3 GPM typical with 20°C facility water to achieve specified cooling capacity
Electrical Requirements		188-253 VAC, 60 Hz single phase 180-220 VAC, 50 Hz single phase
Amps		11.3 A

Specifications subject to change without notice.

**Notes:** Refer to the serial number plate on the rear of the Chiller for model and electrical data.  
 Cooling capacity (watts x 3.41) = BTU/hour. Performance specifications determined at ambient temperature of 20°C (68°F).  
 Positive Displacement Pump Models: External pressure reducing assembly (Cat. No. 060302) steps down high outlet pressure to 10 to 45psi.

Environmental Conditions      Indoor use only  
 Maximum Altitude:      2000 meters  
 Operating Ambient:      5° to 30°C  
 Relative Humidity:      80% for temperatures to 30°C  
 Installation Category      II  
 Pollution Degree:      2

## Performance Specifications — 50Hz Chillers

### Air-Cooled 1/4-HP, 1/3-HP and 1/2-HP Chillers

<b>Magnetic Drive Centrifugal Pump (50Hz)</b>						
Model:    Rfg = Refrigerating Only Rfg / Htg = Refrigerating & Heating						
<b>Model Type</b>	<b>Rfg</b>	<b>Rfg / Htg</b>	<b>Rfg</b>	<b>Rfg / Htg</b>	<b>Rfg</b>	<b>Rfg / Htg</b>
Operating Temperature	-10° to 40°C	-10° to 70°C	-10° to 40°C	-10° to 70°C	-10° to 40°C	-10° to 70°C
Cooling Temperature Range	-10° to 40°C	-10° to 50°C	-10° to 40°C	-10° to 50°C	-10° to 40°C	-10° to 50°C
Compressor	1/4 HP		1/3 HP		1/2 HP	
Cooling Capacity @	20°C	800 watts    2732 BTU/hr	1180 watts    4030 BTU/hr	1836 watts    6270 BTU/hr	600 watts    2049 BTU/hr	1181 watts    4033 BTU/hr
	10°C	600 watts    2049 BTU/hr	960 watts    3279 BTU/hr	1181 watts    4033 BTU/hr	400 watts    1355 BTU/hr	772 watts    2637 BTU/hr
	0°C	400 watts    1355 BTU/hr	600 watts    2049 BTU/hr	772 watts    2637 BTU/hr		
Pressure at 0 Flow Rate	9.5 psi / 66 kPa		9.5 psi / 66 kPa		9.5 psi / 66 kPa	
Flow Rate at 0 psi	3.9 gpm / 14.7 lpm		3.9 gpm / 14.7 lpm		3.9 gpm / 14.7 lpm	
Reservoir Capacity	1.1 gal / 4.2 liters		1.1 gal / 4.2 liters		1.1 gal / 4.2 liters	
Dimensions (L x W x H)	27.6 x 14.5 x 22.6 in. 70.2 x 36.8 x 57.5 cm.					
Shipping Weight	131 pounds 59.4 kg		143 pounds 64.8 kg		168 pounds 76.2 kg	
240 V, 50 Hz Chillers	198 to 264V Category II					
Volts Range						
Over Voltage						
Amps	5.6A	5.9A	5.9A	6.2A	7.2A	7.5A

<b>Positive Displacement Pump (50Hz)</b>						
Model: Rfg = Refrigerating Only Rfg / Htg = Refrigerating & Heating						
<b>Model Type</b>	<b>Rfg</b>	<b>Rfg / Htg</b>	<b>Rfg P</b>	<b>Rfg / Htg</b>	<b>Rfg</b>	<b>Rfg / Htg</b>
Operating Temperature	-10° to 40°C	-10°C to 70°C	-10° to 40°C	-10°C to 70°C	-10° to 40°C	-10° to 70°C
Cooling Temperature Range	-10° to 40°C	-10°C to 50°C	-10° to 40°C	-10°C to 50°C	-10° to 40°C	-10° to 50°C
Compressor	1/4 HP		1/3 HP		1/2 HP	
Cooling Capacity @ 20°C 10°C 0°C	700 watts 500 watts 300 watts	2391 BTU/hr 1708 BTU/hr 1025 BTU/hr	1280 watts 935 watts 485 watts	4371 BTU/hr 3193 BTU/hr 1656 BTU/hr	1836 watts 1181 watts 772 watts	6270 BTU/hr 4033 BTU/hr 2637 BTU/hr
Flow Rate @ 0 psi	2.2 gpm / 8.3 lpm		2.2 gpm / 8.3 lpm		2.2 gpm / 8.3 lpm	
Pump Pressure (adjustable)	20 to 83 psi 138 to 572 kPa		20 to 83 psi 138 to 572 kPa		20 to 83 psi 138 to 572 kPa	
Reservoir Capacity	1.1 gal / 4.2 liters		1.1 gal / 4.2 liters		1.1 gal / 4.2 liters	
Dimensions (L x W x H)	27.6 x 14.5 x 22.6 in. 70.2 x 36.8 x 57.5 cm.					
Shipping Weight	141 pounds 64 kg		153 pounds 69 kg		178 pounds 81 kg	
240 V, 50 Hz Chillers Volts Range Over Voltage	198 to 264V Category II					
Amps	7.1A	7.4A	7.6A	7.9A	9.2A	9.5A

<b>Turbine Pump (50Hz)</b>						
Model: Rfg = Refrigerating Only Rfg / Htg = Refrigerating & Heating						
<b>Model Type</b>	<b>Rfg</b>	<b>Rfg / Htg</b>	<b>Rfg</b>	<b>Rfg / Htg</b>	<b>Rfg</b>	<b>Rfg / Htg</b>
Operating Temperature	-10° to 40°C	-10°C to 70°C	-10° to 40°C	-10°C to 70°C	-10° to 40°C	-10°C to 70°C
Cooling Temperature Range	-10° to 40°C	-10°C to 50°C	-10° to 40°C	-10°C to 50°C	-10° to 40°C	-10°C to 50°C
Compressor	1/4 HP		1/3 HP		1/2 HP	
Cooling Capacity @ 20°C 10°C 0°C	700 watts 500 watts 300 watts	2391 BTU/hr 1708 BTU/hr 1025 BTU/hr	1280 watts 935 watts 485 watts	4371 BTU/hr 3193 BTU/hr 1656 BTU/hr	1836 watts 1181 watts 772 watts	6270 BTU/hr 4033 BTU/hr 2637 BTU/hr
Flow Rate @ 0 psi	2.9 gpm / 11 lpm		2.9 gpm / 11 lpm		2.9 gpm / 11 lpm	
Pump Pressure (adjustable)	20 to 83 psi 138 to 572 kPa		20 to 83 psi 138 to 572 kPa		20 to 83 psi 138 to 572 kPa	
Reservoir Capacity	1.1 gal / 4.2 liters		1.1 gal / 4.2 liters		1.1 gal / 4.2 liters	
Dimensions (L x W x H)	27.6 x 14.5 x 22.6 in. 70.2 x 36.8 x 57.5 cm.					
Shipping Weight	143 pounds 65 kg		156 pounds 71 kg		181 pounds 82 kg	
240 V, 50 Hz Chillers Volts Range Over Voltage	198 to 264V Category II					
Amps	6.8A	7.1A	7.3A	7.6A	8.9A	9.2A

## Air-Cooled 3/4-HP and 1-HP Chillers

<b>Magnetic Drive Centrifugal Pump (50Hz)</b>					
Model: Rfg = Refrigerating Only Rfg / Htg = Refrigerating & Heating					
Model Type		Rfg	Rfg / Htg	Rfg	Rfg / Htg
Operating Temperature		-10° to 40°C	-10° to 70°C	-10° to 40°C	-10 to 70°C
Compressor		3/4 HP		1 HP	
Cooling Capacity @	20°C 10°C 0°C	2250 watts 1600 watts 1075 watts	7684 BTU/hr 5464 BTU/hr 3671 BTU/hr	2750 watts 2050 watts 1400 watts	9238 BTU/hr 7001 BTU/hr 4781 BTU/hr
Pressure at 0 Flow Rate		9.5 psi / 66 kPa		9.5 psi / 66 kPa	
Flow Rate at 0 psi		3.9 gpm / 14.7 lpm		3.9 gpm / 14.7 lpm	
Reservoir Capacity		1.1 gal / 4.2 liters		1.1 gal / 4.2 liters	
Dimensions (L x W x H)		27.6 x 14.5 x 22.6 in. 70.2 x 36.8 x 57.5 cm.			
Shipping Weight		187 pounds 84.8 kg		189 pounds 85.7 kg	
240 V, 50 Hz Volts Range Over Voltage		198 to 264V Category II			
Amps		9.2A	9.5A	9.5A	9.8A

<b>Positive Displacement Pump (50Hz)</b>					
Model: Rfg = Refrigerating Only Rfg / Htg = Refrigerating & Heating					
Model Type		Rfg	Rfg / Htg	Rfg	Rfg / Htg
Operating Temperature		-10° to 40°C	-10° to 70°C	-10° to 40°C	-10° to 70°C
Compressor		3/4 HP		1 HP	
Cooling Capacity @	20°C 10°C 0°C	2200 watts 1500 watts 975 watts	7513 BTU/hr 5123 BTU/hr 3329 BTU/hr	2650 watts 1900 watts 1200 watts	9050 BTU/hr 6489 BTU/hr 4098 BTU/hr
Flow Rate @ 0 psi		2.9 gpm / 11 lpm		2.9 gpm / 11 lpm	
Pump Pressure (adjustable)		20 to 83 psi 138 to 572 kPa		20 to 83 psi 138 to 572 kPa	
Reservoir Capacity		1.1 gal / 4.2 liters		1.1 gal / 4.2 liters	
Dimensions (L x W x H)		27.6 x 14.5 x 22.6 in. 70.2 x 36.8 x 57.5 cm.			
Shipping Weight		197 pounds 89 kg		199 pounds 90 kg	
240 V, 50 Hz Volts Range Over Voltage		198 to 264V Category II			
Amps		11.9A	12.2A	12.2A	12.5A



<b>Turbine Pump (50Hz)</b>					
Model: Rfg = Refrigerating Only Rfg / Htg = Refrigerating & Heating					
<b>Model Type</b>		<b>Rfg</b>	<b>Rfg / Htg</b>	<b>Rfg</b>	<b>Rfg / Htg</b>
Operating Temperature		-10° to 40°C	-10° to 70°C	-10° to 40°C	-10° to 70°C
Compressor		3/4 HP		1 HP	
Cooling Capacity @	20°C 10°C 0°C	2200 watts 1500 watts 975 watts	7513 BTU/hr 5123 BTU/hr 3329 BTU/hr	2650 watts 1900 watts 1200 watts	9050 BTU/hr 6489 BTU/hr 4098 BTU/hr
Flow Rate @ 0 psi		2.9 gpm / 11 lpm		2.9 gpm / 11 lpm	
Pump Pressure (adjustable)		20 to 83 psi 138 to 572 kPa		20 to 83 psi 138 to 572 kPa	
Reservoir Capacity		1.1 gal / 4.2 liters		1.1 gal / 4.2 liters	
Dimensions (L x W x H)		27.6 x 14.5 x 22.6 in. 70.2 x 36.8 x 57.5 cm.			
Shipping Weight		197 pounds 89 kg		199 pounds 90 kg	
240 V, 50 Hz Volts Range Over Voltage		198 to 264V Category II			
Amps		11.9A	12.2A	12.2A	12.5A

### Water-Cooled 3/4-HP Chillers

<b>Turbine Pump (240 VAC)</b>		
Model: Rfg = Refrigerating Only Rfg / Htg = Refrigerating & Heating		
<b>Model Type</b>	<b>Rfg</b>	<b>Rfg / Htg</b>
Operating Temperature	-10° to 40°C	-10°C to 70°C
Cooling Temperature Range	-10° to 40°C	-10°C to 50°C
Compressor	3/4 HP	
Cooling Capacity	1550 watts @ 20°C fluid temperature	
Flow Rate @ 0 psi	3.5 gpm / 13.2 lpm	
Pump Pressure (adjustable)	20 to 90 psi 138 to 621 kPa	
Reservoir Capacity	1.1 gal / 4.2 liters	
Dimensions (L x W x H)	27.6 x 14.5 x 22.6 in. 70.2 x 36.8 x 57.5 cm.	
Shipping Weight	187 pounds / 84.8 kg	
Facility Water Requirement	Temperature Range: 8° to 30°C Pressure: 20 PSI minimum; 100 PSI maximum Flow: 3 GPM typical with 20°C facility water to achieve specified cooling capacity	
Electrical Requirements	216-264 VAC, 50 Hz single phase	
Amps	11.3 A	

Specifications subject to change without notice.

**Notes:** Refer to the serial number plate on the rear of the Chiller for model and electrical data.  
Cooling capacity (watts x 3.41) = BTU/hour. Performance specifications determined at ambient temperature of 20°C (68°F).  
Positive Displacement Pump Models: External pressure reducing assembly (Cat. No. 060302) steps down high outlet pressure to 10 to 45psi.

Environmental Conditions Indoor use only  
Maximum Altitude: 2000 meters  
Operating Ambient: 5° to 30°C  
Relative Humidity: 80% for temperatures to 30°C  
Installation Category: II  
Pollution Degree: 2

# Diagrams and Schematics

## Electrical Wiring Diagram

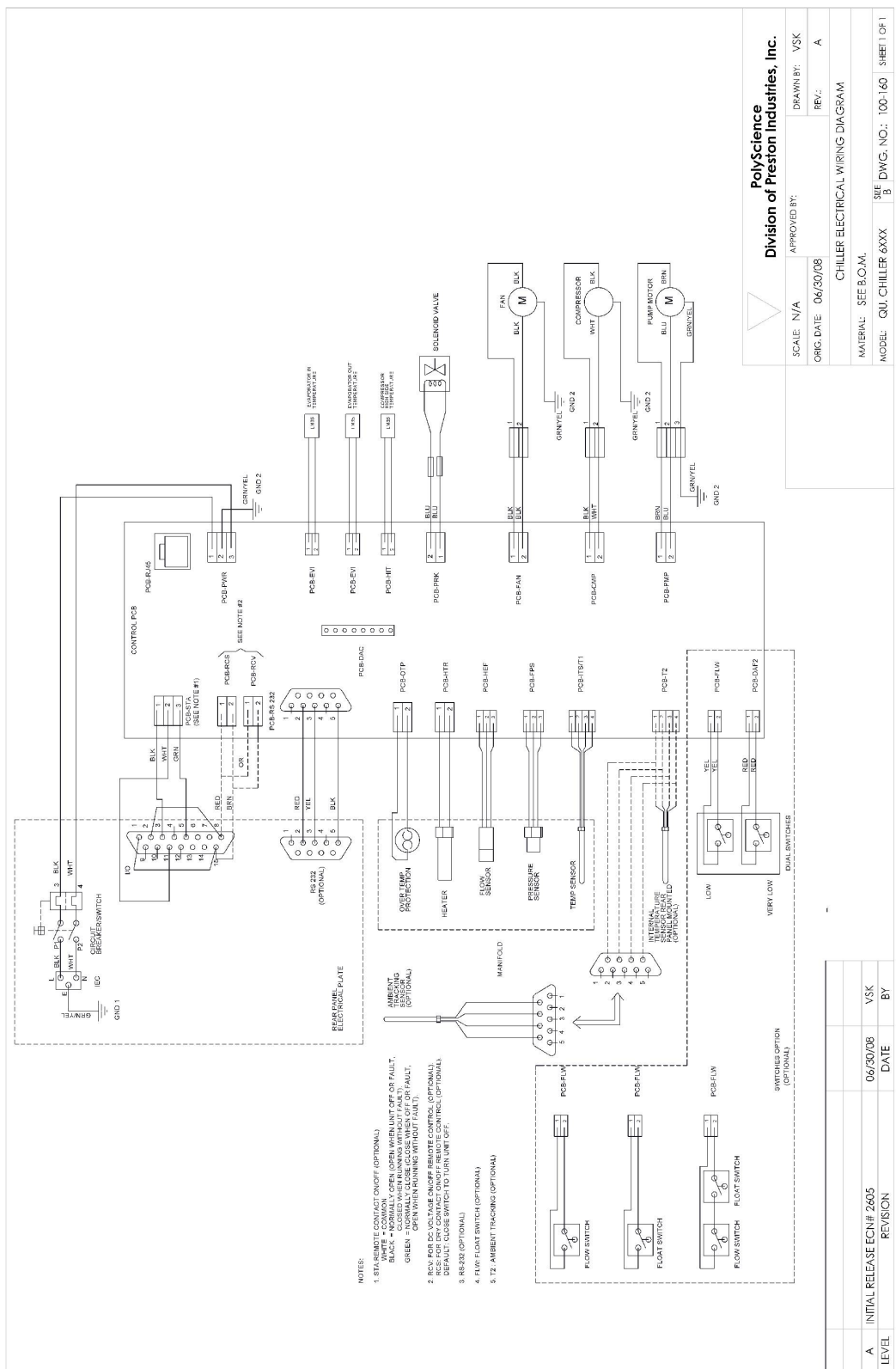

# Flow Schematic

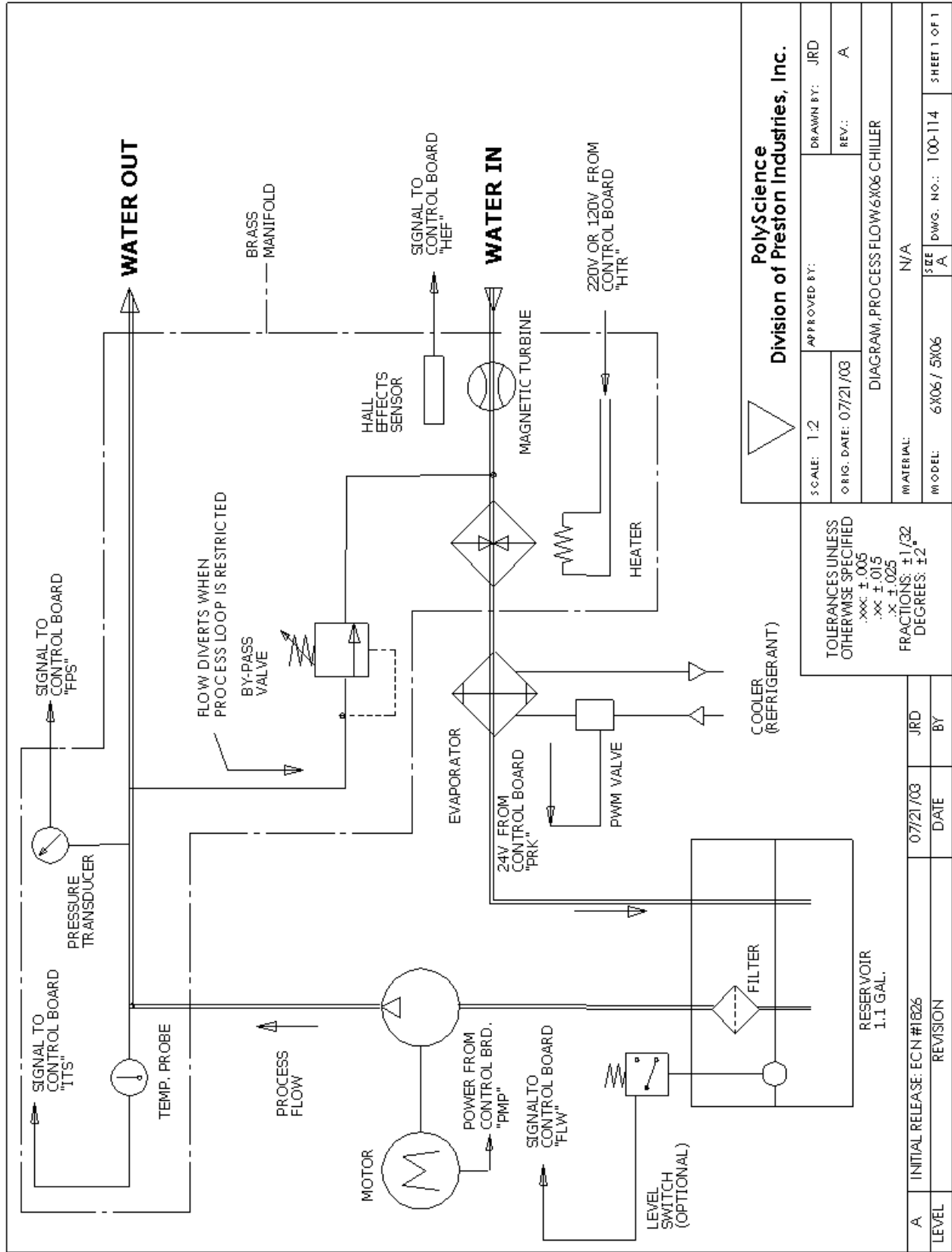

<p style="text-align: center;"><b>PolyScience</b> Division of Preston Industries, Inc.</p>		SCALE: 1:2	APPROVED BY: JRD
		ORIG. DATE: 07/21/03	REV.: A
MATERIAL: N/A		DIAGRAM, PROCESS FLOW 6X06 CHILLER	
MODEL: 6X06 / 5X06	SEE A	DWG. NO.: 100-114	SHEET 1 OF 1

<p>TOLERANCES UNLESS OTHERWISE SPECIFIED</p> <ul style="list-style-type: none"> <li>.xxx ± .005</li> <li>.xx ± .015</li> <li>.x ± .025</li> </ul> <p>FRACTIONS: 1/32</p> <p>DEGREES: ± 2°</p>		DATE: 07/21/03	BY: JRD
LEVEL: A	INITIAL RELEASE: ECN #1826	REVISION:	

### Remote On/Off Status Alarm Pinout

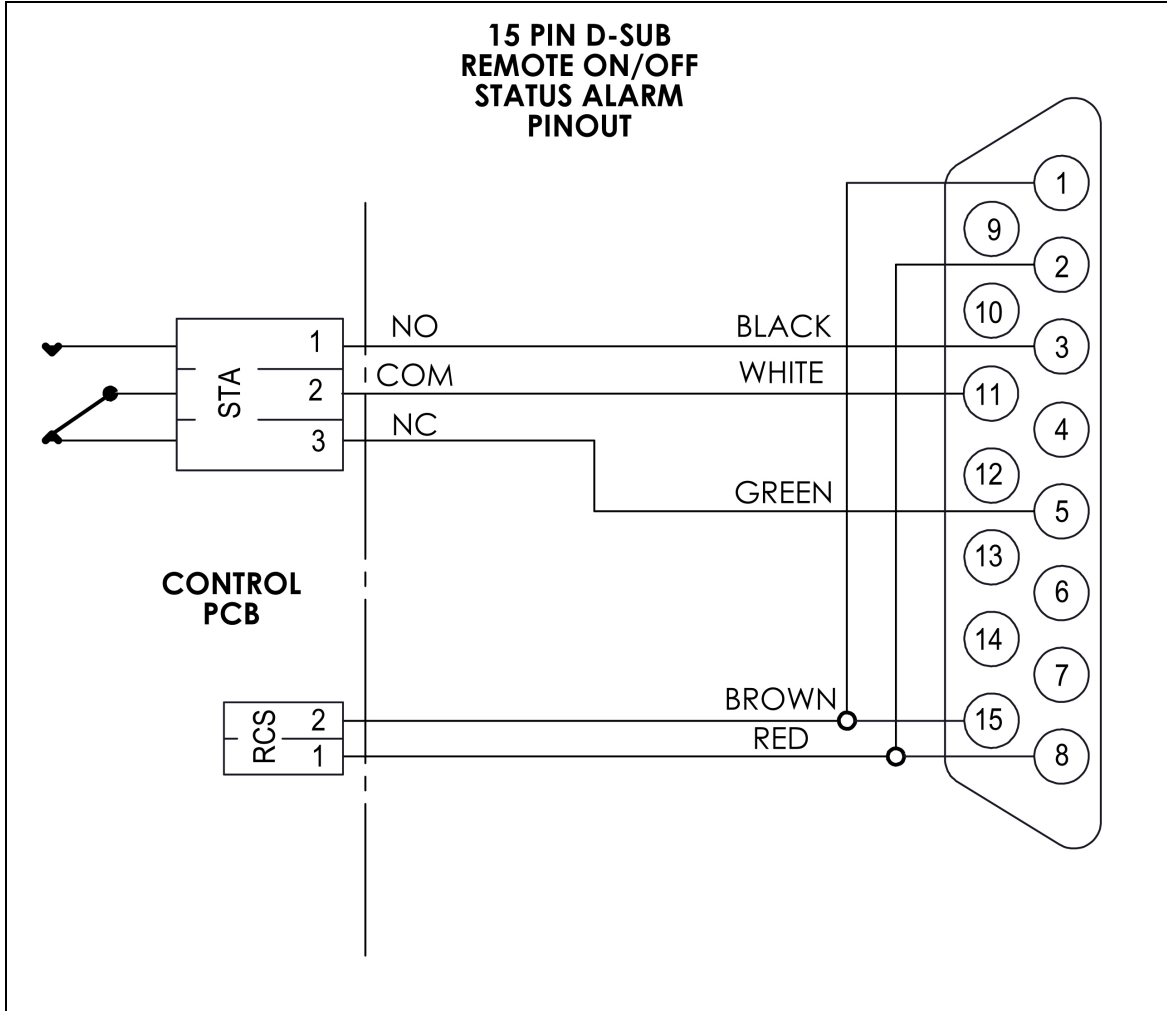

## Replacement Parts

<b>All 1/4-HP Units</b>	<b>120V, 60Hz</b>	<b>240V, 50Hz</b>
Condensing unit, ¼ HP	750-157	750-158
Magnetic Drive Pump (models without heat)	525-551	525-552
Magnetic Drive Pump (models with heat)	525-553	525-554
Positive Displacement Motor (all models)	215-535	215-529
Positive Displacement Pump (all models)	215-105	215-105
Turbine Pump (all models)	215-656	215-305
Circuit Breaker	215-330	215-330
Fan blade	215-748	215-031
Fan motor	215-704	215-030

<b>All 1/3-HP Units</b>	<b>120V, 60Hz</b>	<b>240V, 50Hz</b>
Condensing unit, 1/3 HP	750-306	750-189
Magnetic Drive Pump (models without heat)	525-551	525-552
Magnetic Drive Pump (models with heat)	525-553	525-554
Positive Displacement Motor (all models)	215-535	215-529
Positive Displacement Pump (all models)	215-105	215-105
Turbine Pump (all models)	215-656	215-305
Circuit Breaker (magnetic drive pump models)	215-330	215-330
Circuit Breaker (positive displacement and turbine pump models)	215-388	215-330
Fan motor	215-730	215-724

<b>All 1/2-HP Units</b>	<b>120V, 60Hz</b>	<b>240V, 50Hz</b>
Condensing unit, ½ HP	750-308	750-309
Magnetic Drive Pump (models without heat)	525-551	525-552
Magnetic Drive Pump (models with heat)	525-553	525-554
Positive Displacement Motor (all models)	215-535	215-529
Positive Displacement Pump (all models)	215-105	215-105
Turbine Pump (all models)	215-656	215-305
Circuit Breaker	215-388	215-330
Fan blade	215-767	215-769
Fan motor	215-768	215-708

<b>All 3/4-HP Units</b>	<b>208-230V, 60Hz</b>	<b>240V, 50Hz</b>
Compressor, 3/4 HP (air-cooled models)	750-304	750-303
Compressor, 3/4 HP (water-cooled models)	750-898	750-895
Magnetic Drive Pump (models without heat)	525-552	525-552
Magnetic Drive Pump (models with heat)	525-554	525-554
Positive Displacement Motor (all models)	215-217	215-217
Positive Displacement Pump (all models)	215-106	215-106
Turbine Pump (all models)	215-305	215-305
Circuit Breaker	215-330	215-330
Fan Blade	215-631	215-631
Fan Motor	525-731	525-731

<b>All 1-HP Units</b>	<b>208-230V, 60HZ</b>	<b>240V, 50HZ</b>
Compressor, 1 HP	750-304	750-303
Magnetic Drive Pump (for models without heat)	525-552	525-552
Magnetic Drive Pump (for models with heat)	525-554	525-554
Positive Displacement Motor (all models)	215-217	215-217
Positive Displacement Pump (all models)	215-106	215-106
Turbine Pump (all models)	215-305	215-305
Circuit Breaker	215-330	215-330
Fan blade	215-631	215-631
Fan motor	525-731	525-731

<b>Additional Parts</b>	
Operator's Manual	110-240
Tubing Adapter Kit	510-288
Air Filter	750-855
Fluid Filter	565-102
Flow Indicator	330-571
Reservoir Cap	300-460
Reservoir Spill Cup	300-459

<b>Fluids</b>		
polycool MIX -25	Case = 5 x ½ gallon (1.9 L)	004-300060
polycool MIX 30	Case = 5 x ½ gallon (1.9 L)	004-300062
polycool EG -25	1 gallon (3.8 L)	060340
polycool PG -20	1 gallon (3.8 L)	060320
polycool HC -50	1 gallon (3.8 L)	060330
polyclean CLARIFIER	8 oz (237 ml) Case = 12 x 8 oz (237 ml)	004-300040 004-300041

## RS232 Communications

**Serial Connector** — A 9-pin D-connector is provided on the back panel of the Chiller for RS232 data communication. A serial cable that uses only the following pins should be used to connect the Chiller to the computer:

- Pin #2 — data read (data from computer)
- Pin #3 — data transmit (data to computer)
- Pin #5 — signal ground

**RS232 Protocol** — The controller uses the following RS232 protocol:

- Data bits — 8
- Parity — none
- Stop bits — 1
- Flow control — none
- Baud rate — selectable (Chiller and PC baud rates must match).

**Communications Commands** — Commands must be entered in the exact format shown. Do not send a [LF] (line feed) after the [CR] (character return). Be sure to follow character case exactly. A response followed by an exclamation point (!) indicates that a command was executed correctly. A question mark (?) indicates that the Chiller could not execute the command (either because it was in an improper format or the values were outside the allowable range). A response must be received from the Chiller before another command can be sent. All responses are terminated with a single [CR].

Command Description	Command Format	Values	Return Message
Set command echo	SEi[CR]	Echo: i = 1 No Echo: i = 0	![CR]
Set on / off	SOi[CR]	On: i = 1 Off: i = 0	![CR]
Set set point	SSxxx[CR]	x = ASCII digit	![CR]
Read set point temperature	RS[CR]		+xxx.x[CR] or - xxx.x[CR]
Read temperature	RT[CR]		+xxx.x[CR] or - xxx.x[CR]
Read probe 1 temperature	R1[CR]		+xxx.x[CR] or - xxx.x[CR]
Read probe 2 temperature	R2[CR]		+xxx.x[CR] or - xxx.x[CR]
Read temperature units	RU[CR]	C or F	C[CR] or F[CR]
Read status	RW[CR]	1 = Run 0 = Standby	1[CR] or 0[CR]
Read pressure in PSI	RP[CR]		+ xxx.x[CR]
Read pressure in kPa	RK[CR]		+ xxx.x[CR]
Read flow in GPM	RG[CR]		+ xxx.x[CR]
Read flow in LPM	RL[CR]		+ xxx.x[CR]
Read remote control voltage	RC[CR]		+ xxx.x[CR]
Read line voltage	RV[CR]		+ xxx.x[CR]
Read compressor discharge temperature (°C)	RH[CR]		+xxx.x[CR] or - xxx.x[CR]
Read remote probe temperature	RR[CR]		+xxx.x[CR] or - xxx.x[CR]
Read ambient temperature on PCB	RA[CR]		+xxx.x[CR] or - xxx.x[CR]



Command Description	Command Format	Values	Return Message
Read float switch status	RX[CR]	0 = fluid level is ok 1 = fluid level is low	0[CR] or 1[CR]
Read fault status (see <i>Display, Alarm and Error Messages</i> )	RF[CR]	00 = System OK 18 = Standby mode 02 – 17 = Fault	![CR]

## Certificate of Compliance

All Chillers are tested after assembly to ensure that the product meets or exceeds published mechanical and safety specifications as well as your satisfaction. The Certificate of Compliance is included with the Chiller. The following graph explains the steps involved in a typical test.

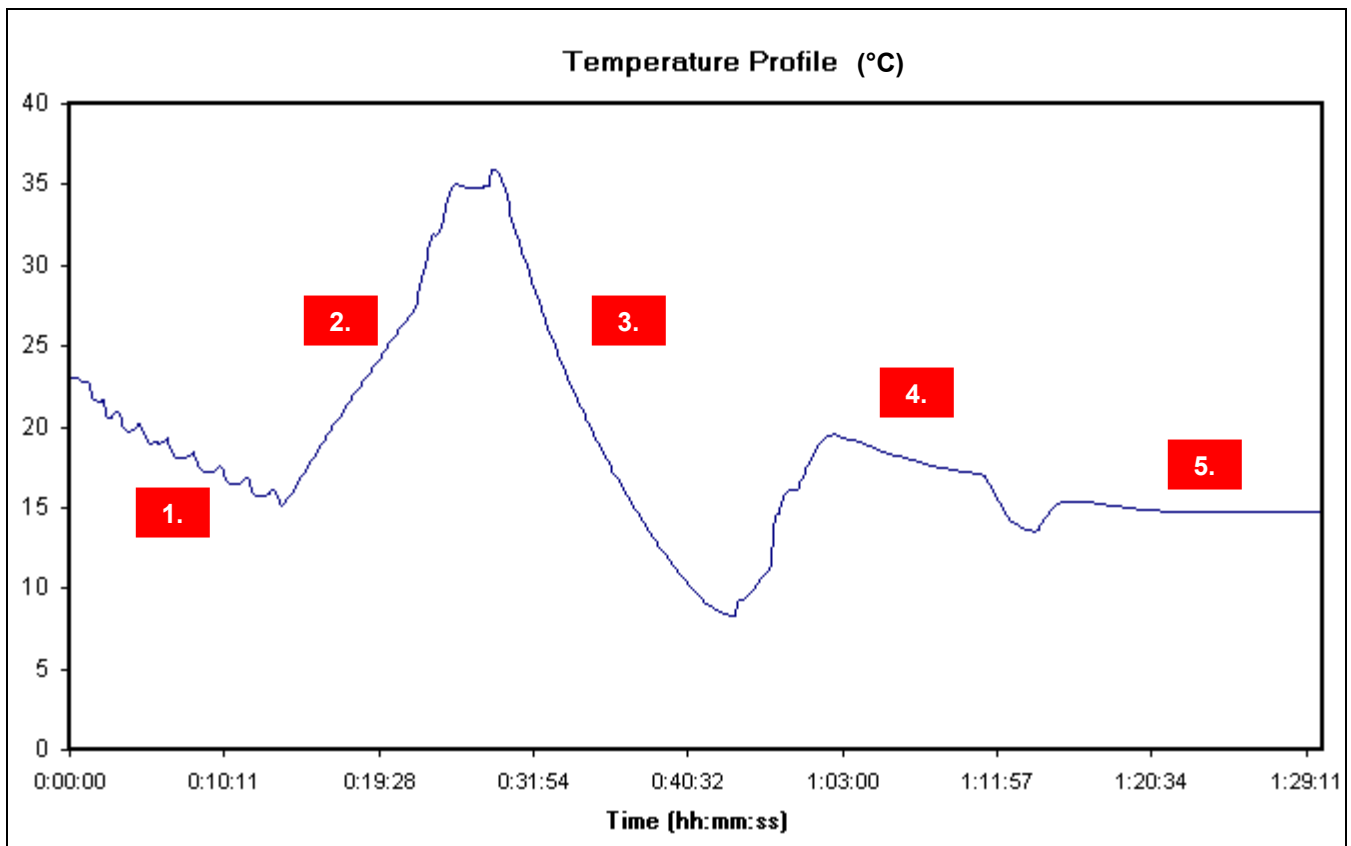

1. Unit runs and On/Off cycle.
2. Heat performance of unit measured.
3. Cooling performance of unit measured.
4. Heat load applied to Chiller to simulate real application conditions. The heat load applied is based on the Chiller's cooling capacity.
5. Temperature stability of unit measured.

## Equipment Disposal (WEEE Directive)



or



This equipment is marked with the crossed out wheeled bin symbol to indicate it is covered by the Waste Electrical and Electronic Equipment (WEEE) Directive and is not to be disposed of as unsorted municipal waste. **Any products marked with this symbol must be collected separately, according to the regulatory guidelines in your area.**

It is your responsibility to correctly dispose of this equipment at lifecycle-end by handing it over to an authorized facility for separate collection and recycling. It is also your responsibility to decontaminate the equipment in case of biological, chemical and/or radiological contamination, so as to protect the persons involved in the disposal and recycling of the equipment from health hazards. By doing so, you will help to conserve natural and environmental resources and you will ensure that your equipment is recycled in a manner that protects human health.

Requirements for waste collection, reuse, recycling, and recovery programs vary by regulatory authority at your location. Contact your local responsible body (e.g., your laboratory manager) or authorized representative for information regarding applicable disposal regulations.

## Service and Technical Support

If you have followed the troubleshooting steps and your Recirculating Chiller fails to operate properly, contact the supplier from whom the unit was purchased. Have the following information available for the customer service person:

- Model, Serial Number, and Voltage (from back panel)
- Date of purchase and your purchase order number
- Suppliers' order number or invoice number
- A summary of your problem

## Warranty

The manufacturer agrees to correct for the original user of the product, either by repair (using new or refurbished parts), or at the manufacturer's election, by replacement (with a new or refurbished product), any defects in material or workmanship which develop during the warranty period. The standard warranty is twenty-four (24) months after delivery of the product. In the event of replacement, the replacement unit will be warranted for the remainder of the original warranty period or ninety (90) days, whichever is longer. For purposes of this limited warranty, "refurbished" means a product or part that has been returned to its original specifications. In the event of a defect, these are your exclusive remedies.

If the product should require service, contact the manufacturer's/supplier's office for instructions. When return of the product is necessary, a return authorization number is assigned and the product should be shipped, transportation charges pre-paid, in either its original packaging or packaging affording an equal degree of protection to the indicated service center. To insure prompt handling, the return authorization number must be placed on the outside of the package. A detailed explanation of the defect should be enclosed with the item.

The warranty shall not apply if the defect or malfunction was caused by accident, neglect, unreasonable use, improper service, acts of God, modification by any party other than the manufacturer, or other causes not arising out of defects in material or workmanship.

**EXCLUSION OF IMPLIED WARRANTIES.** THERE ARE NO WARRANTIES, EXPRESSED OR IMPLIED, INCLUDING, BUT NOT LIMITED TO, THOSE OF MERCHANTABILITY OR FITNESS FOR A PARTICULAR PURPOSE WHICH EXTEND BEYOND THE DESCRIPTION AND PERIOD AS STATED IN THE OPERATOR'S MANUAL INCLUDED WITH EACH PRODUCT.

**LIMITATION ON DAMAGES.** THE MANUFACTURER'S SOLE OBLIGATION UNDER THE WARRANTY IS LIMITED TO THE REPAIR OR REPLACEMENT OF A DEFECTIVE PRODUCT AND THE MANUFACTURER SHALL NOT, IN ANY EVENT, BE LIABLE FOR ANY INCIDENTAL OR CONSEQUENTIAL DAMAGES OF ANY KIND RESULTING FROM USE OR POSSESSION OF THIS PRODUCT.

Some states do not allow: (A) limitations on how long an implied warranty lasts; or (B) the exclusion or limitation of incidental or consequential damages, so the above limitations or exclusions may not apply to you. This warranty gives you specific legal rights and you may have other rights that vary from state to state.

Manufactured by:

**PolyScience**

6600 W. Touhy Avenue Niles, IL 60714 U.S.A.

1-800-229-7569 • 1-847-647-0611

[www.polyscience.com](http://www.polyscience.com)