

News from the mobile Telescope at CHARA

Rainer Koehler (rkoehler@gsu.edu)

Robert Ligon, Gail Schaefer, Nic Scott, Narsireddy Anugu, Christopher Farrington,
Karolina Kubiak, Cyprien Lanthermann, Nils Turner, Douglas Gies,
and everyone else at CHARA

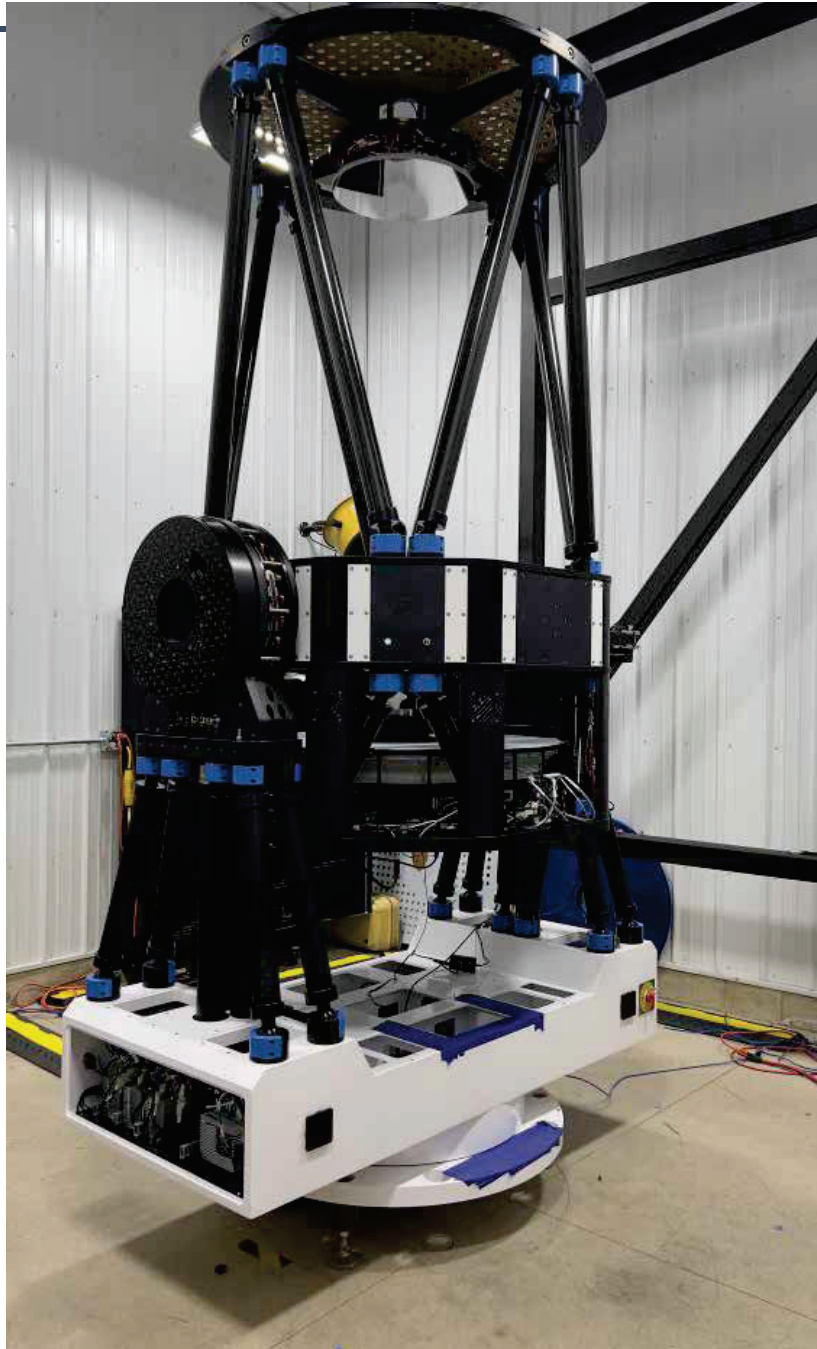

- Built by PlaneWave Instruments
- 1m diameter f/12
- Ritchey-Chrétien design
- “Off-the-shelf”





First light: 2024-03-19

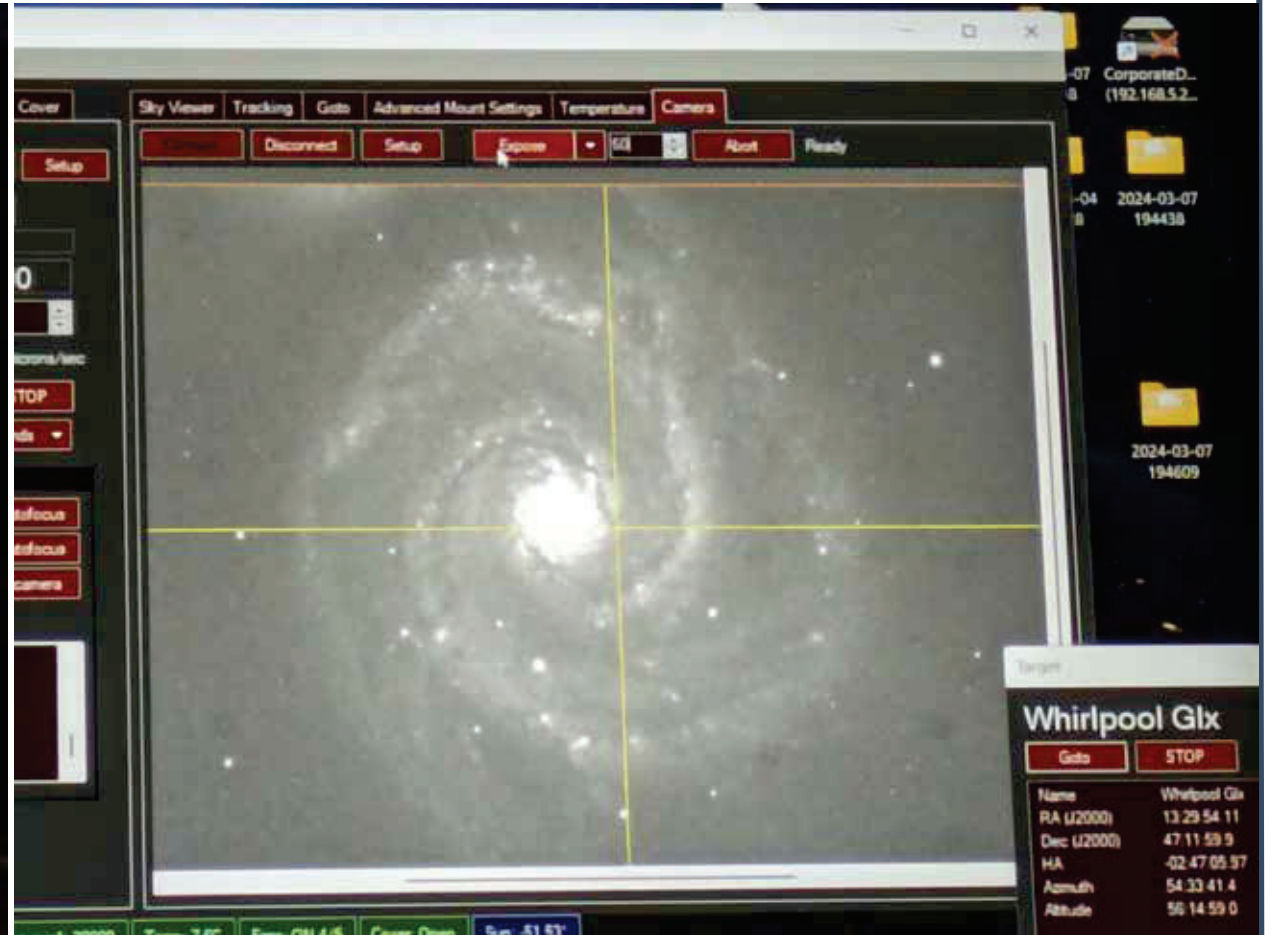

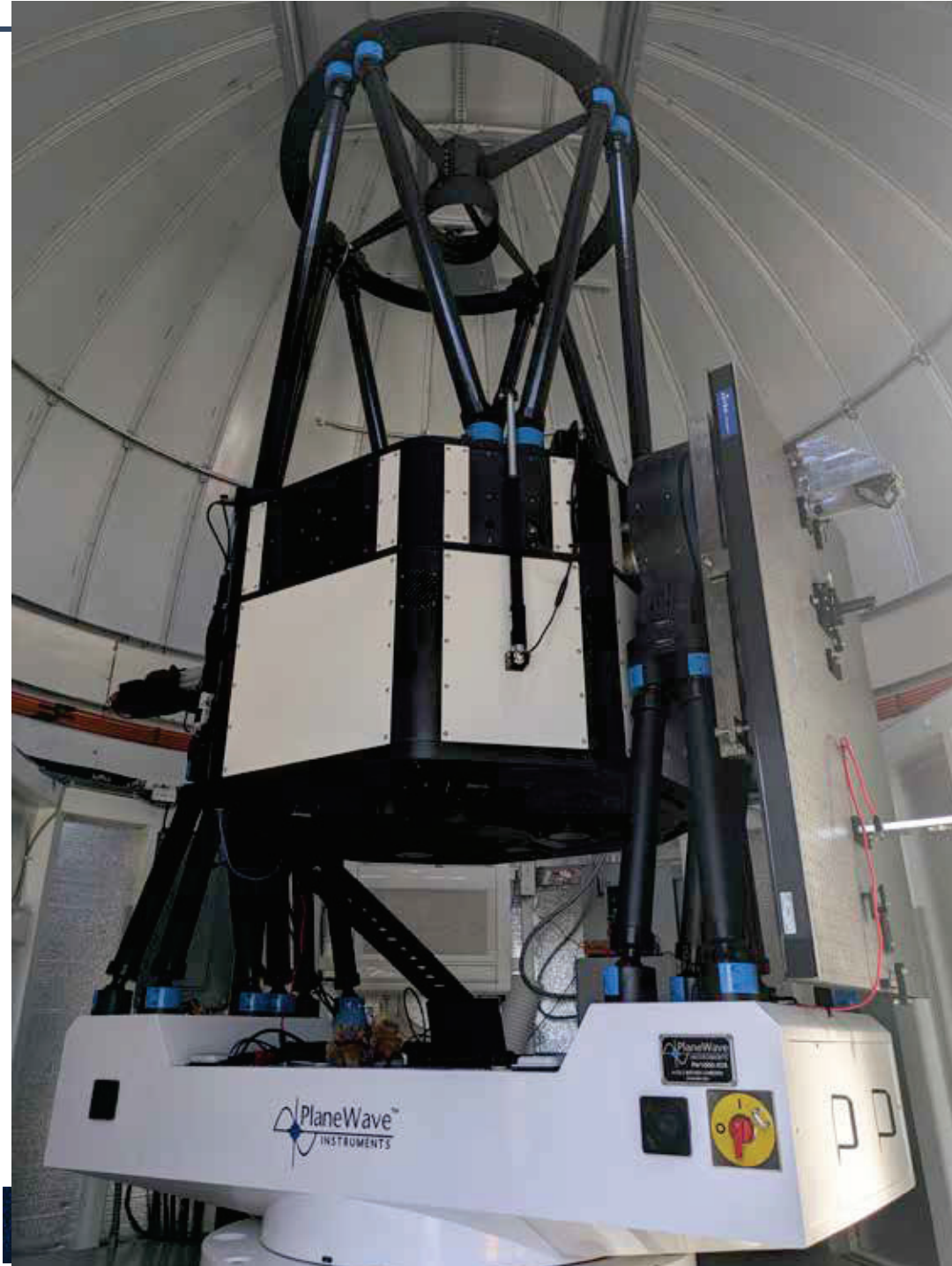



Dome & Enclosure

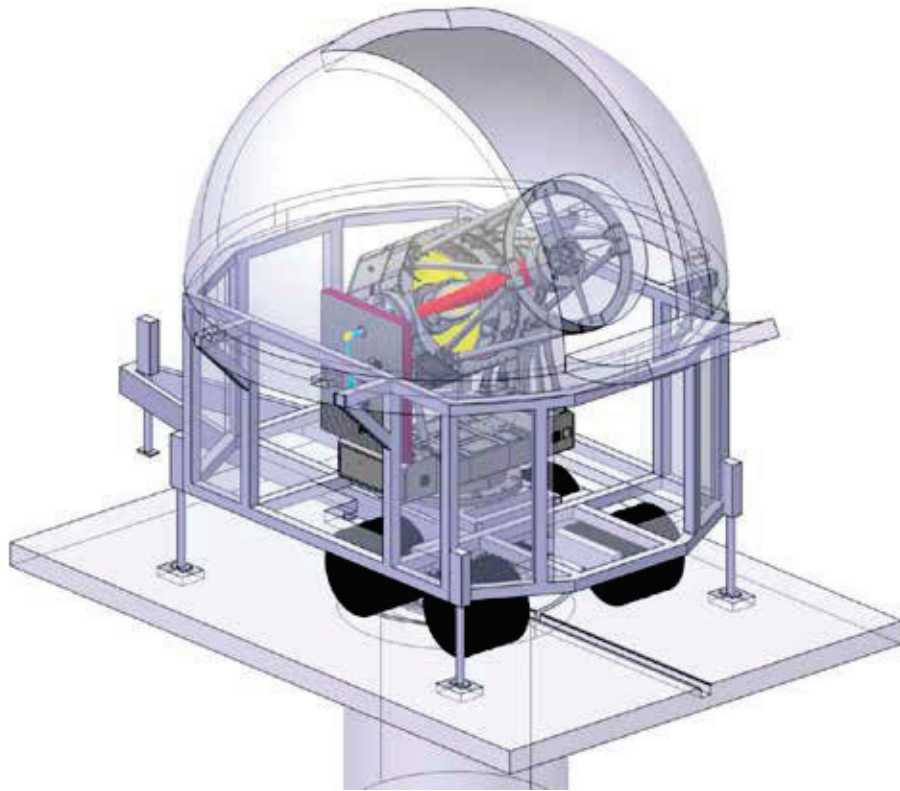



Does it move?

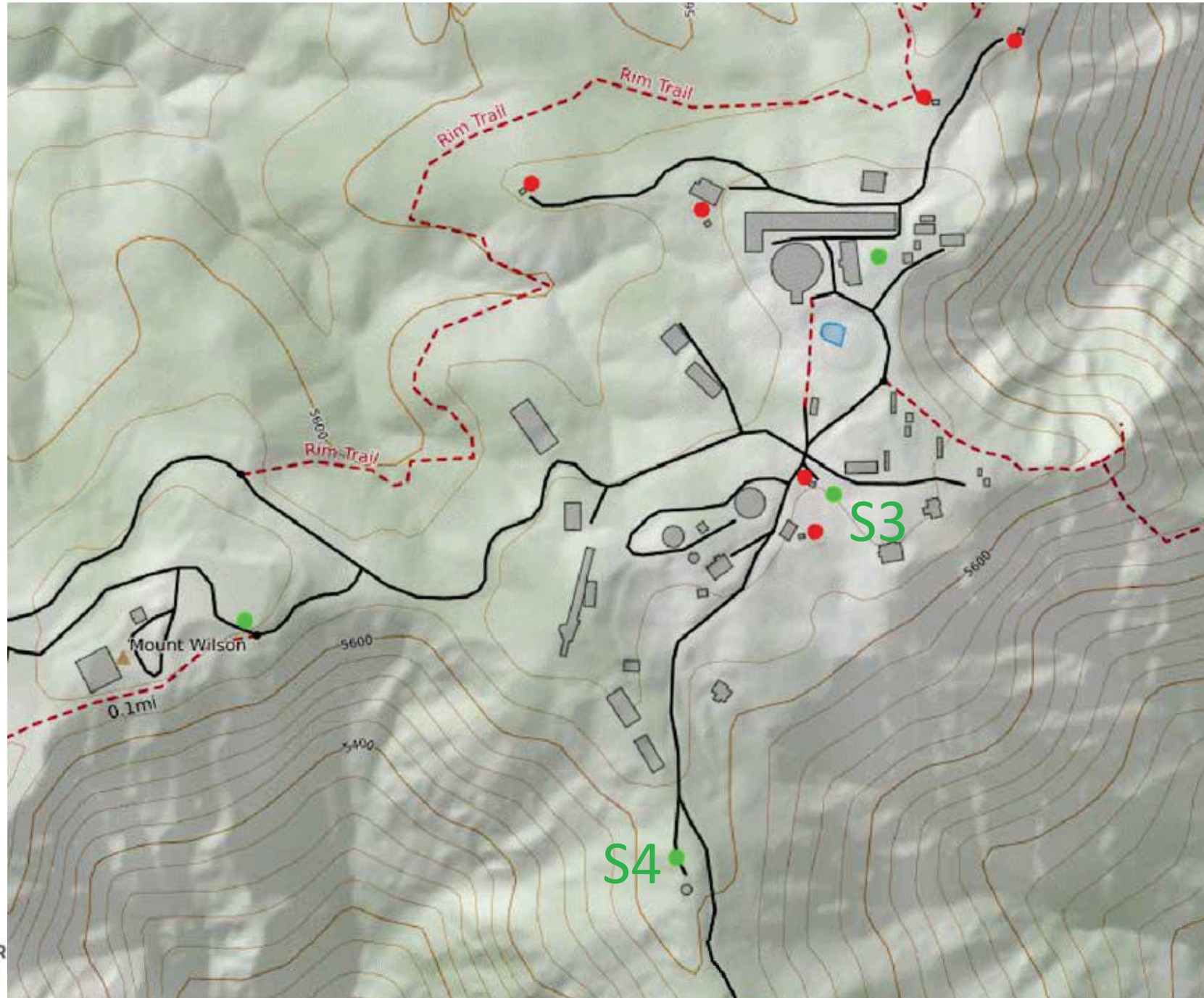



Move to S4 on 2025-Nov-06





Move to S4 on 2025-Nov-06



Nic Scott



Victor Castillo



T7 at S4



- Storm
- No power (except generator)
- No network
- No observations



Back at S3

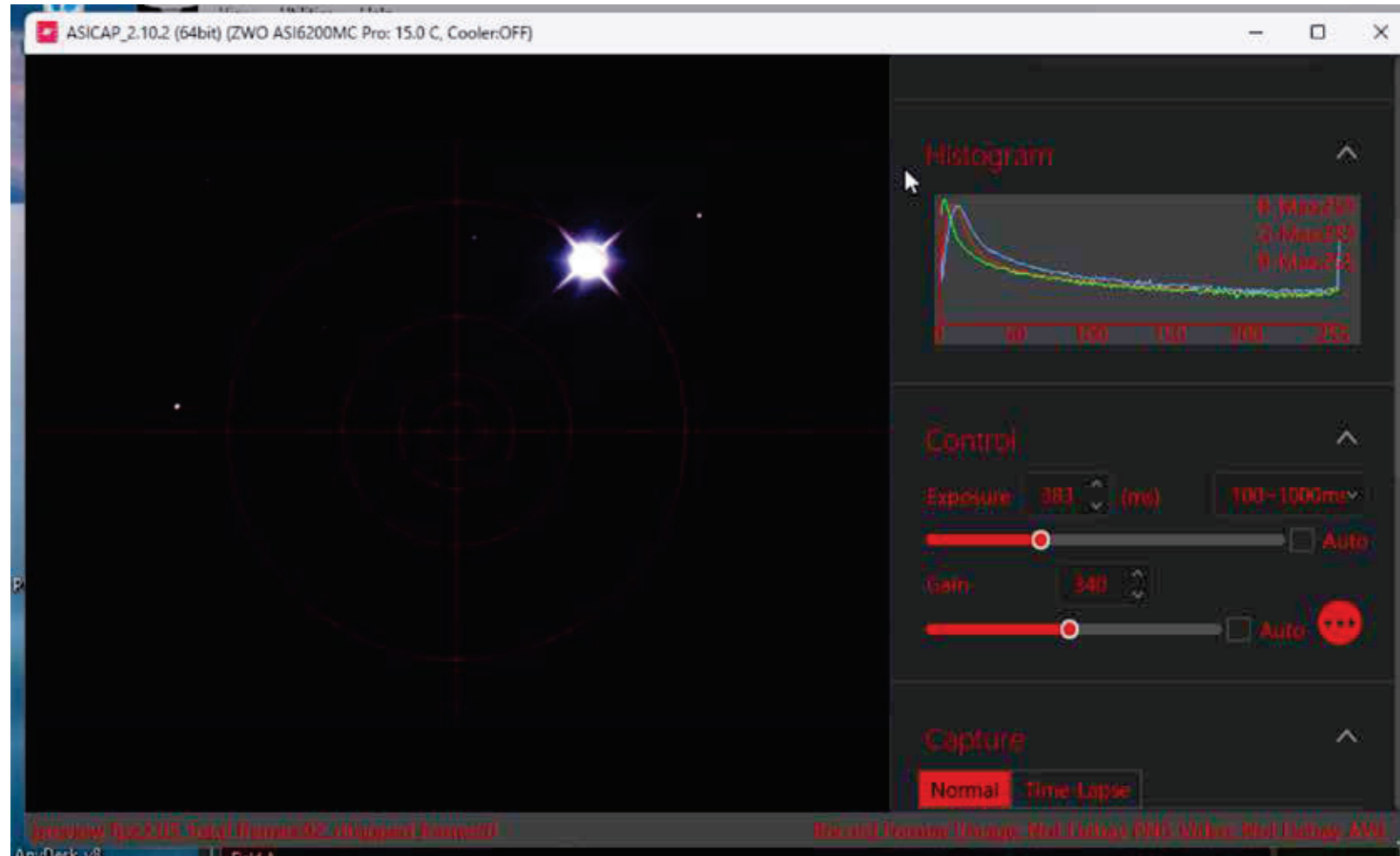

Pointing changed by only a few arsec



Nasmyth Instrument Bench - March 2025

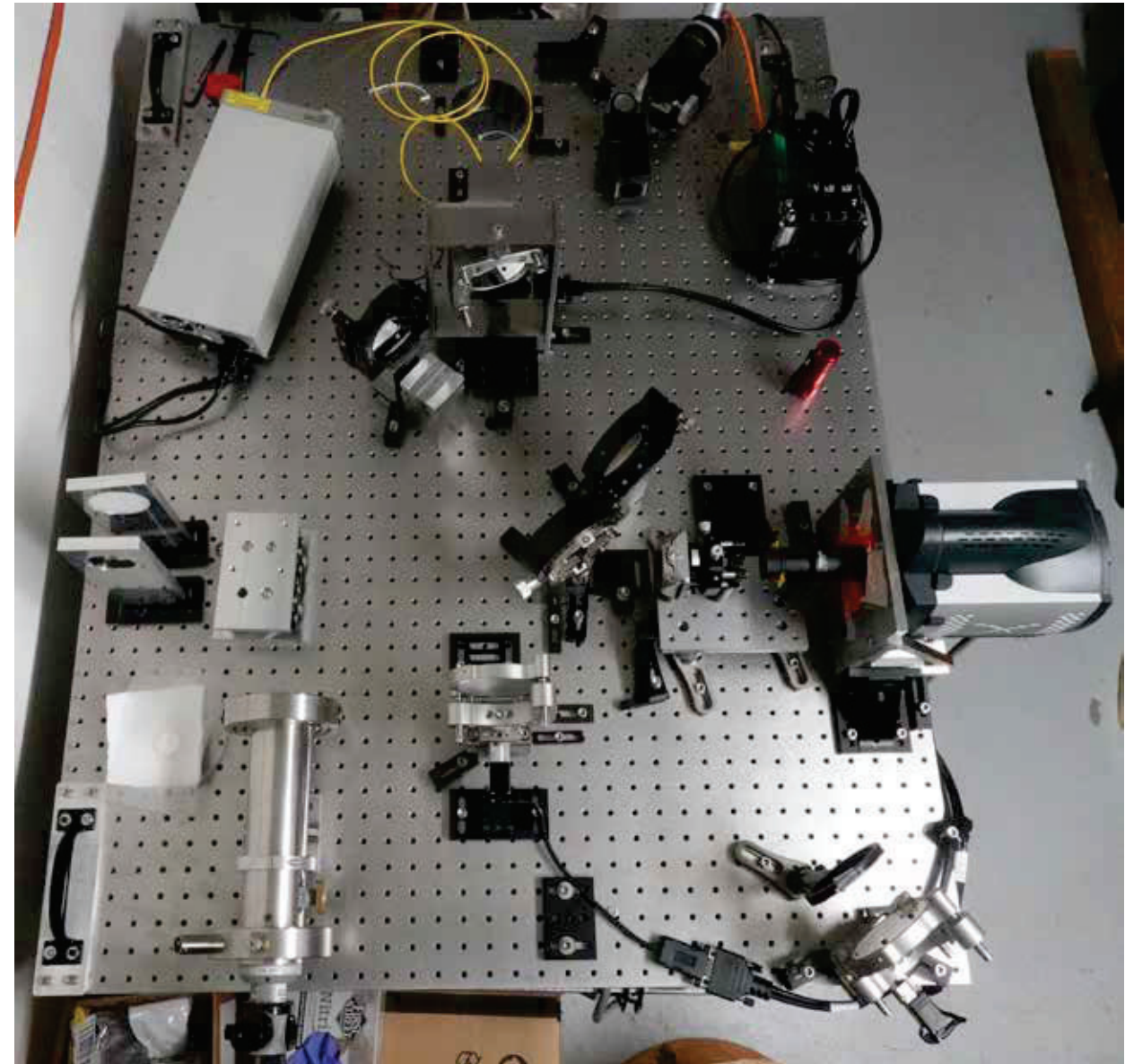
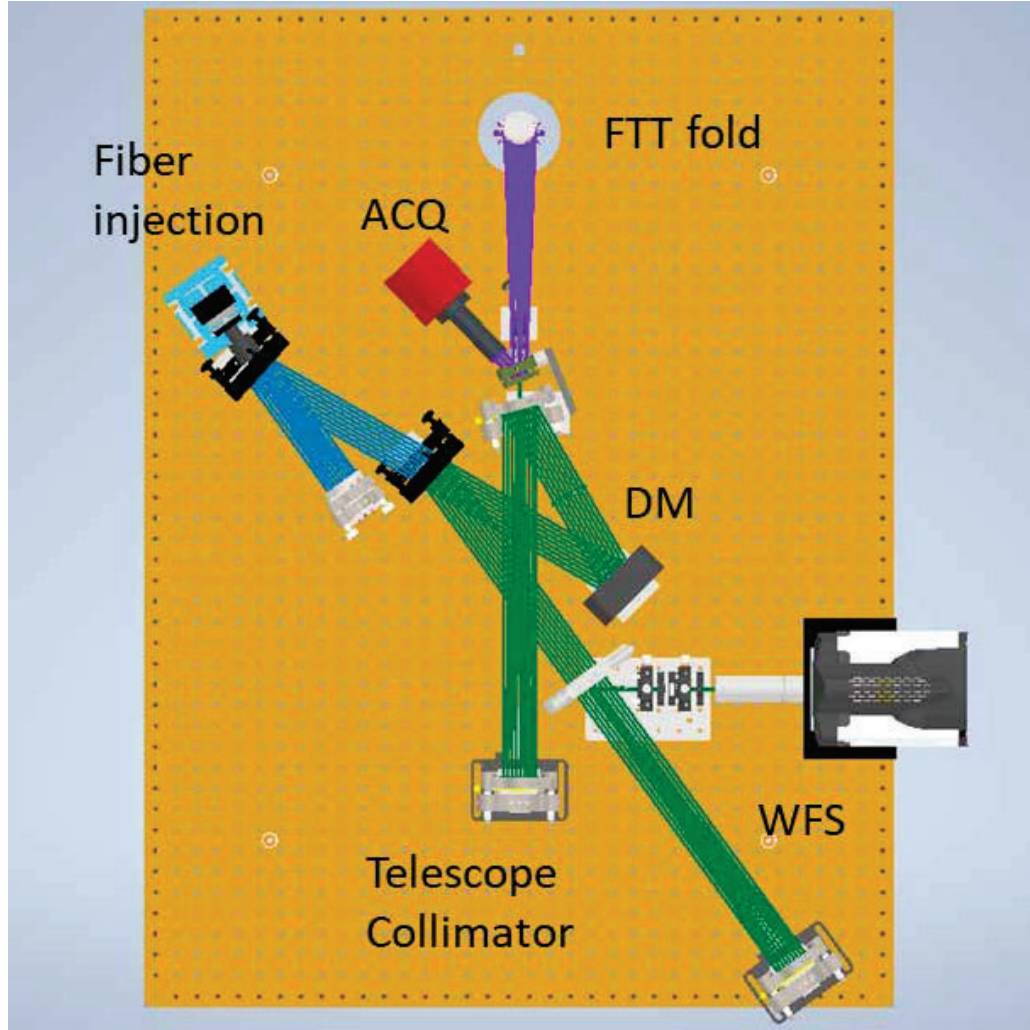



Nasmyth Instrument Bench - last week

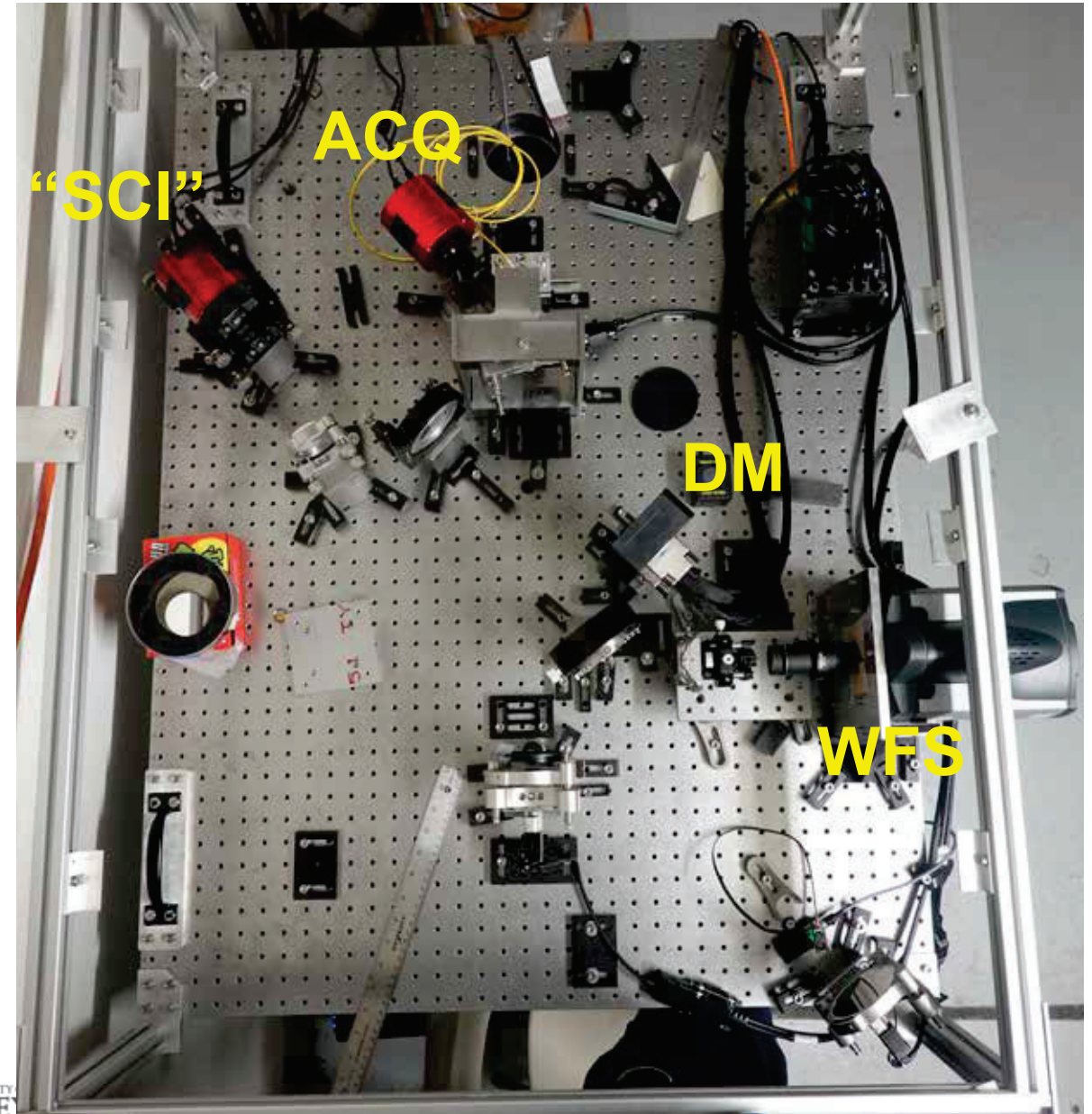
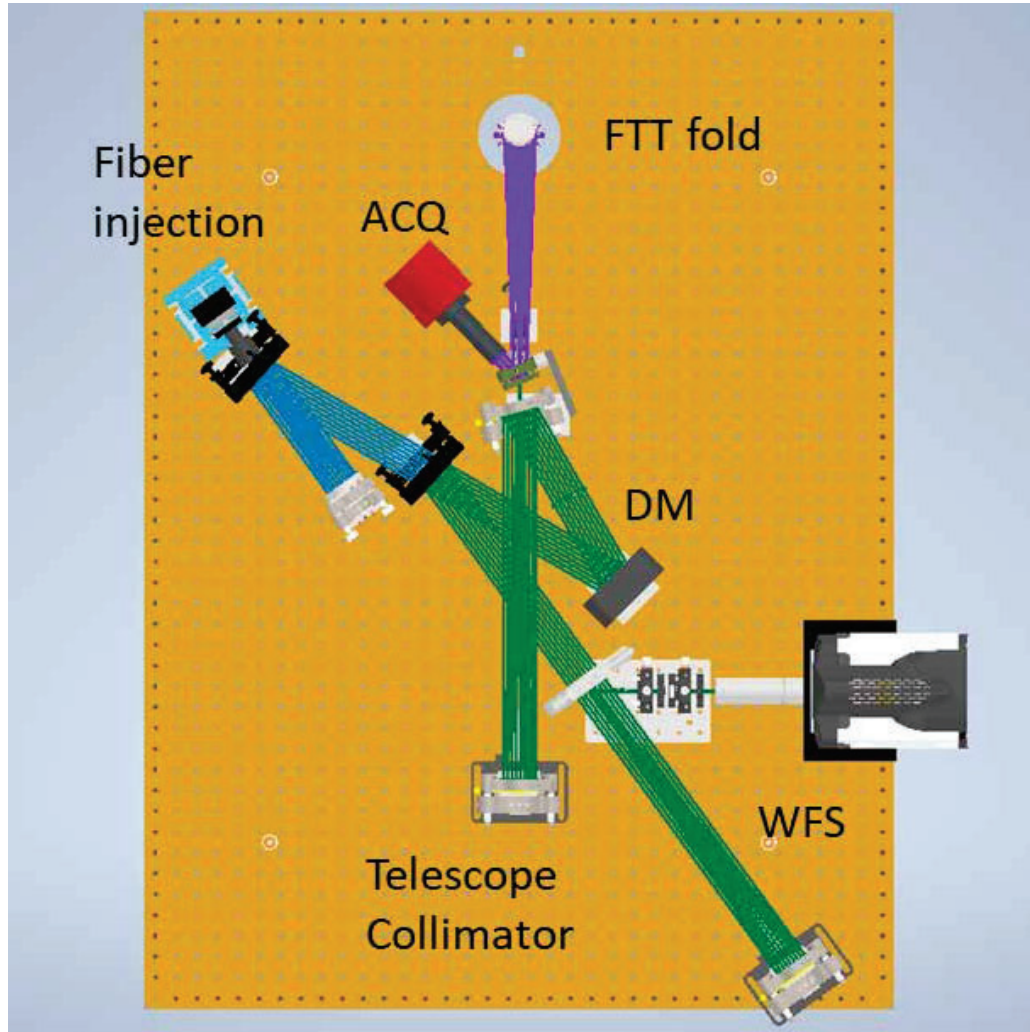



Fun with the ALPAO-DM

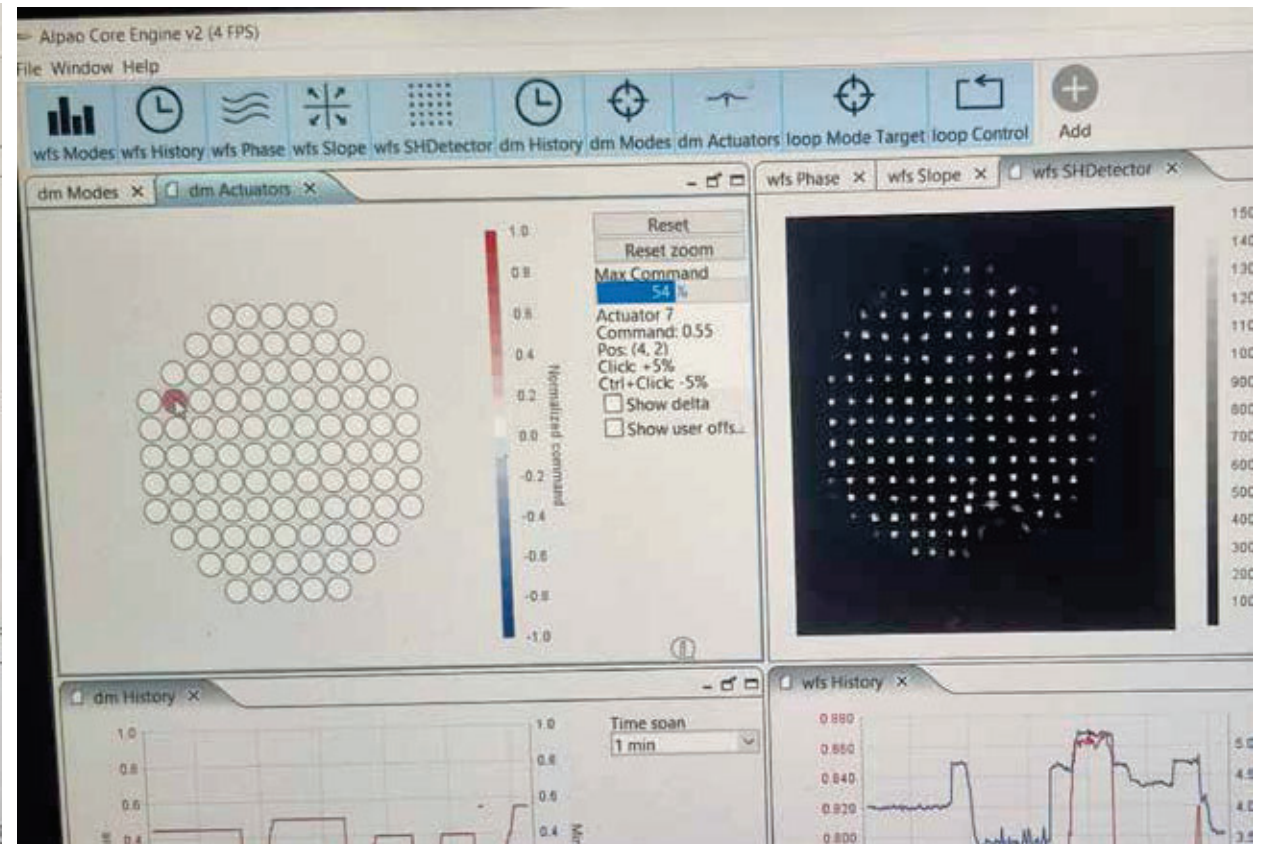
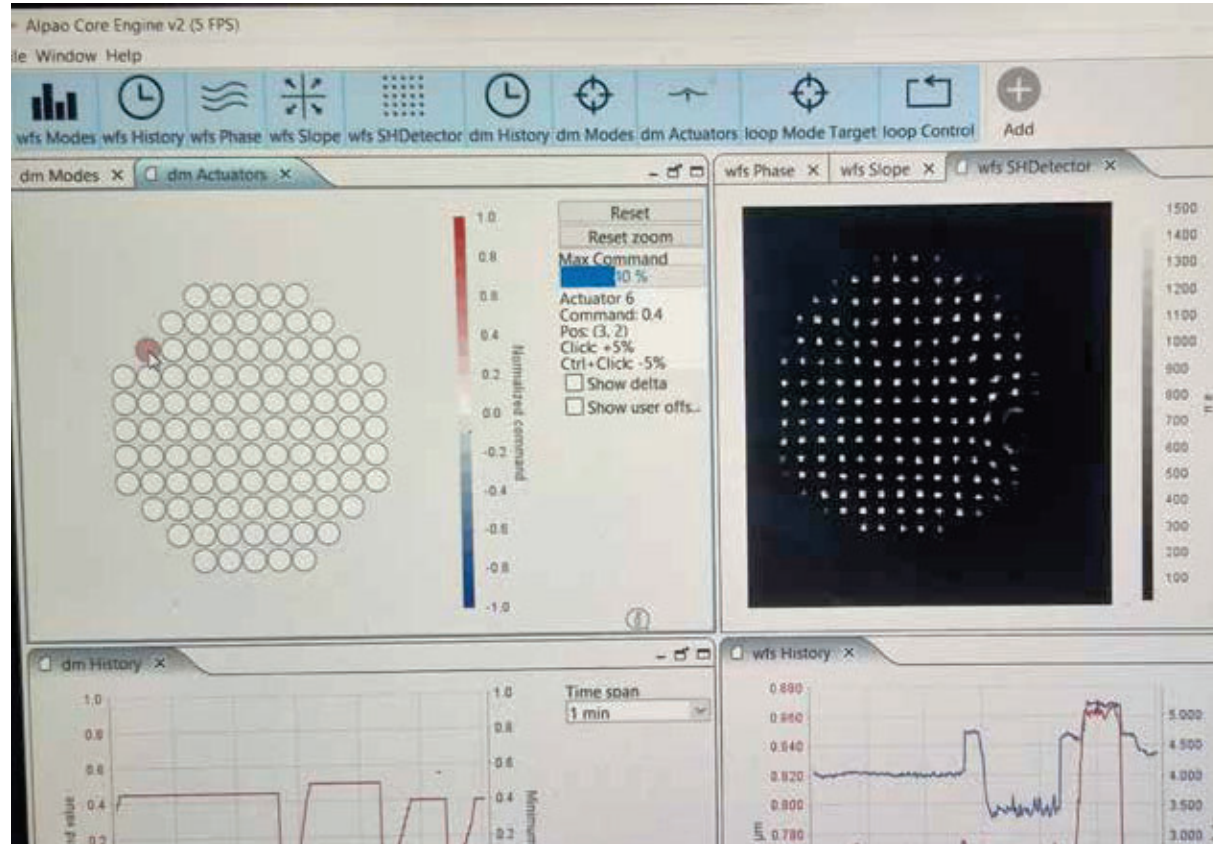

Fun with the ALPAO-DM

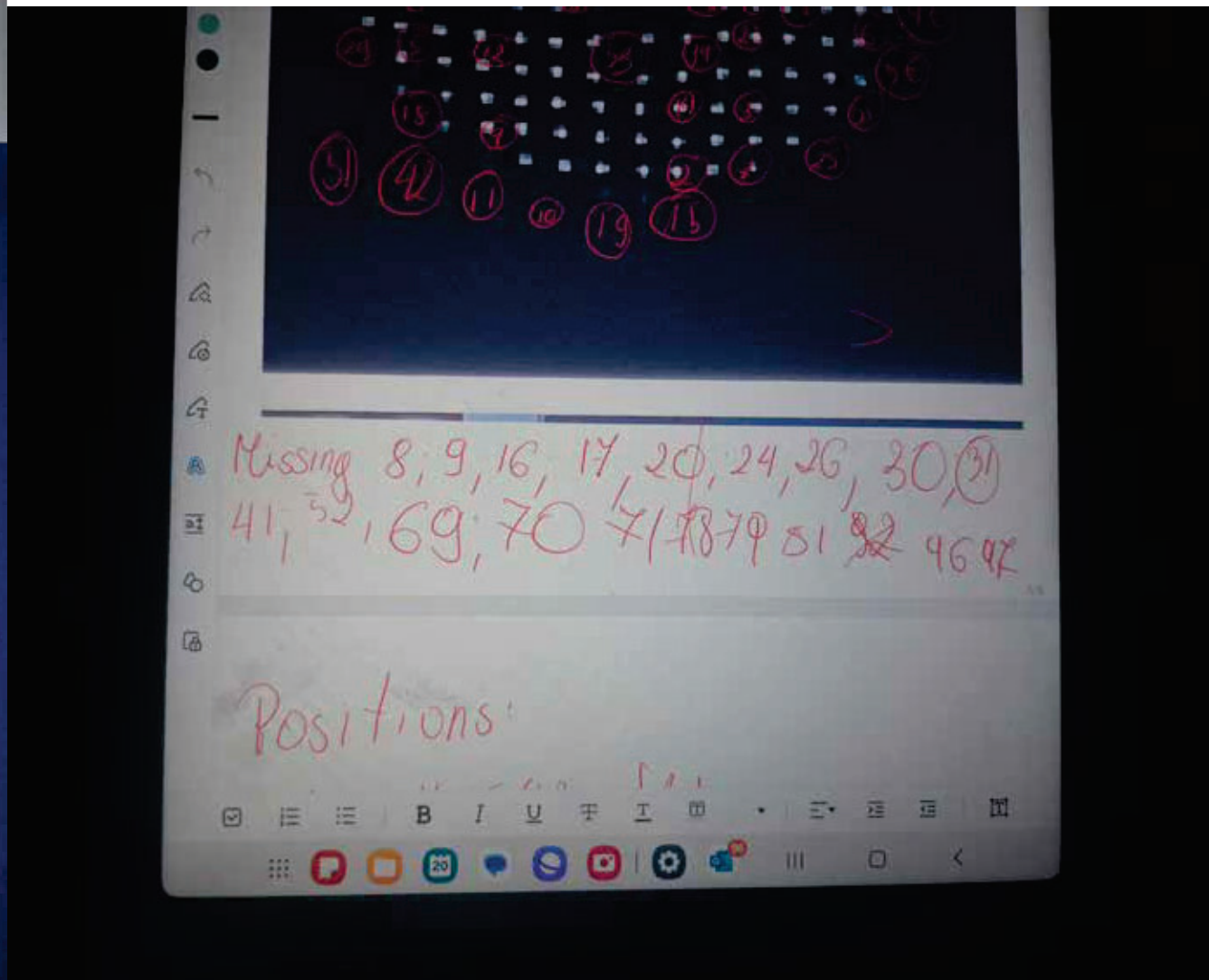
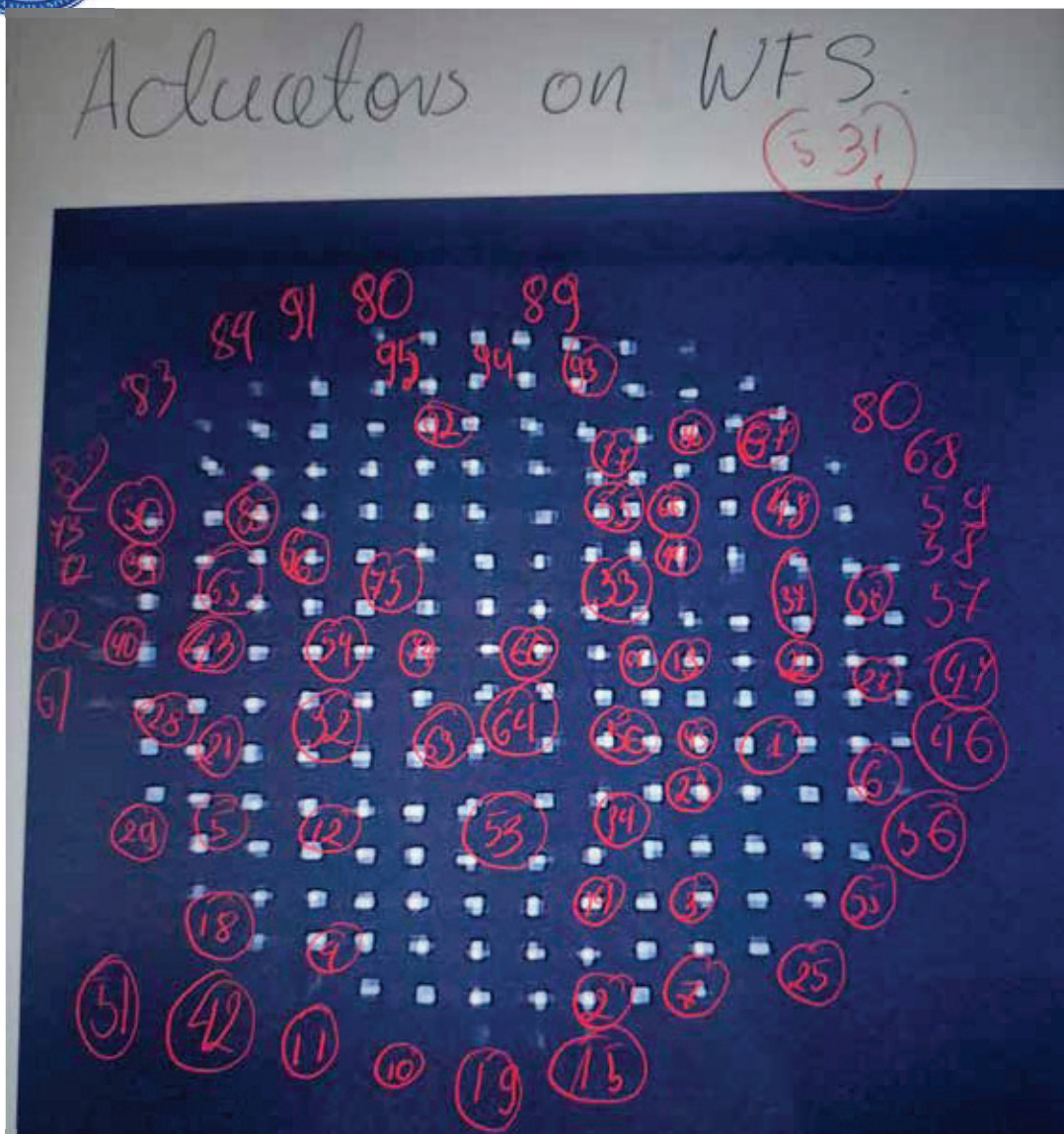

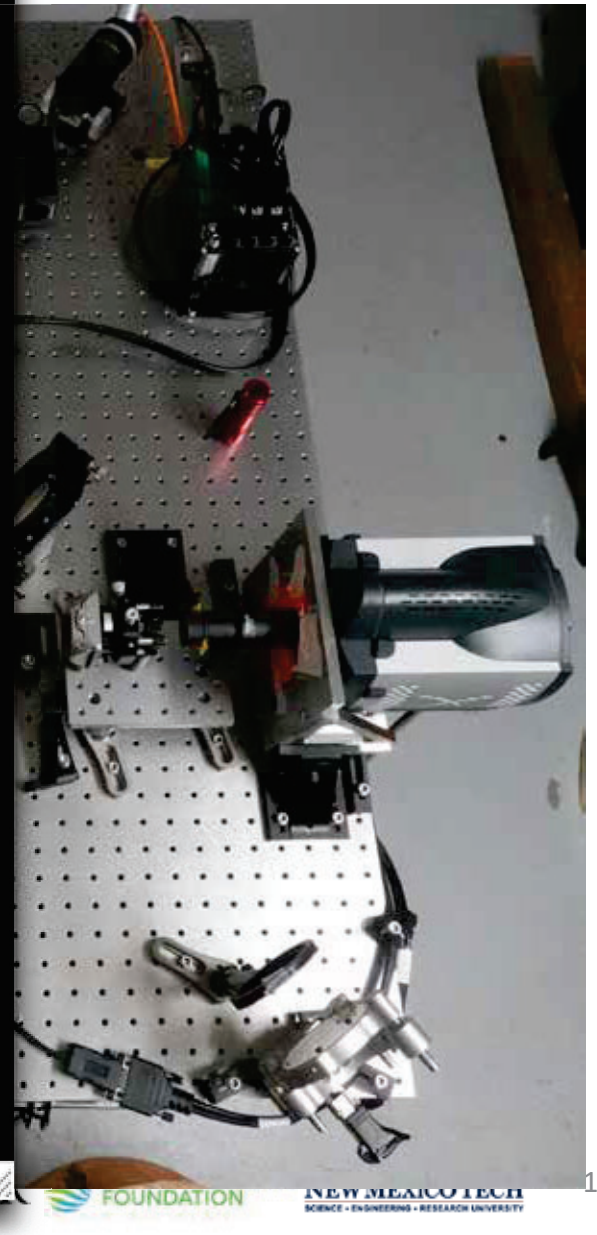
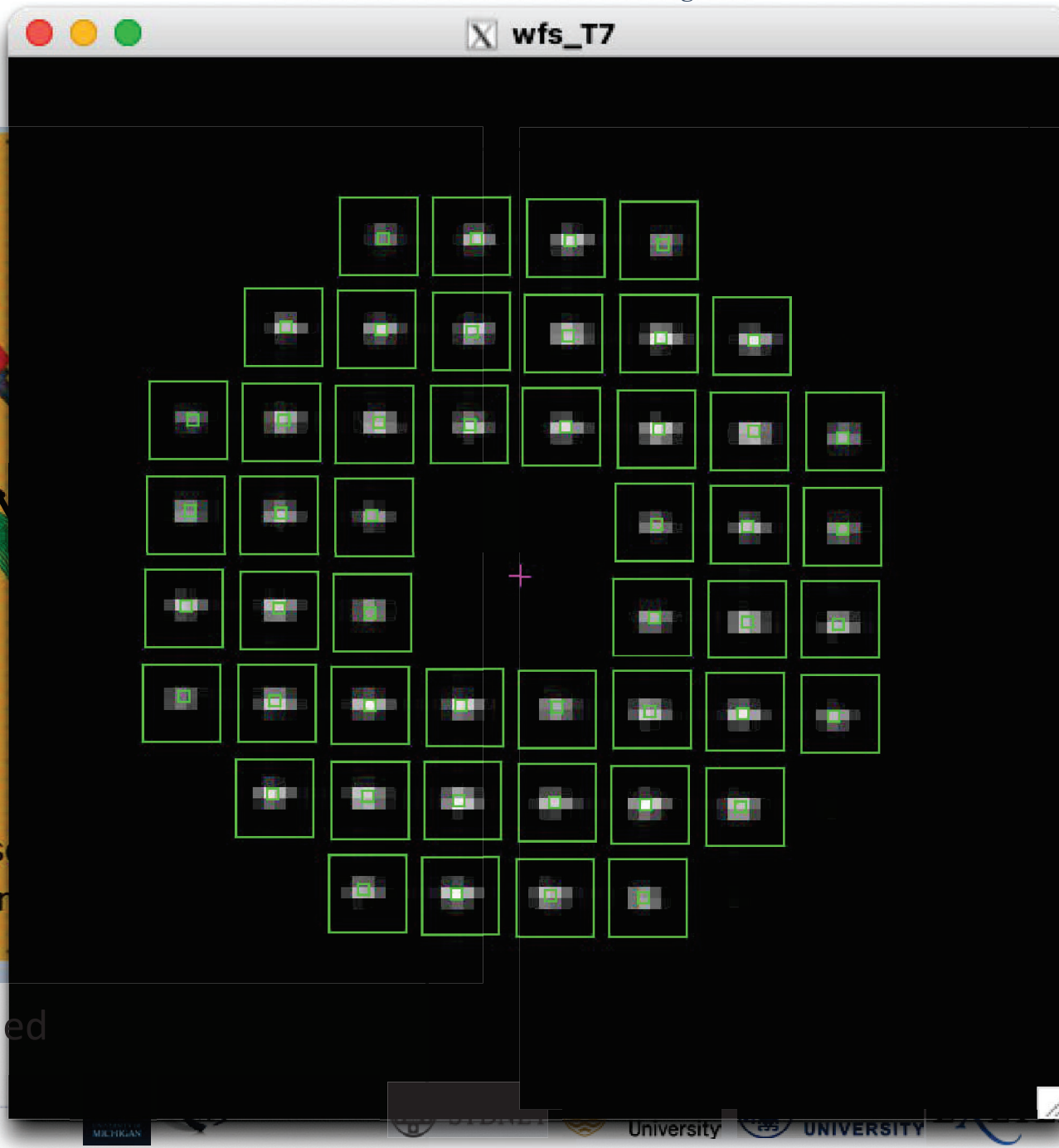
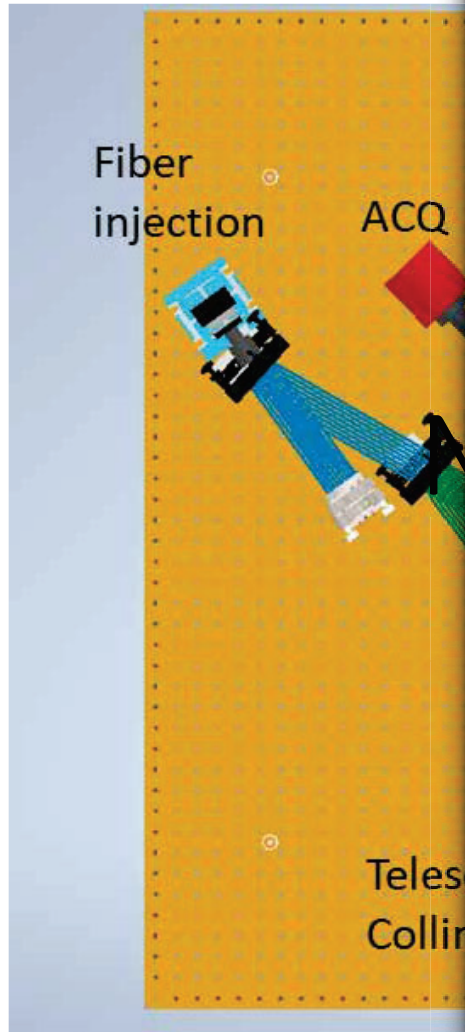

WFS path installed and aligned



TO DO LIST

- Mount NIB on telescope
- Connect Fibers
- ...
- Fringes!





Results so far: pretty pictures

